

KDC-MP925 KDC-W8027

SERVICE MANUAL

CD mechanism extension cord (24PIN) : W05-0935-00

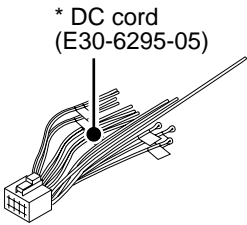
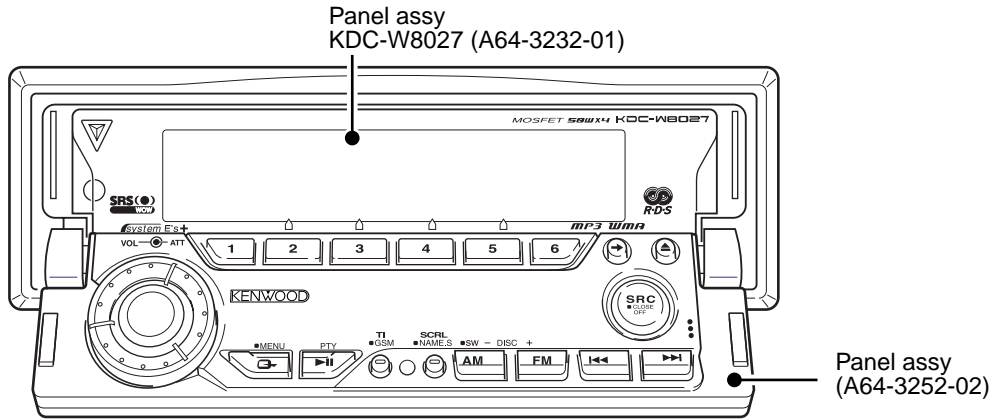
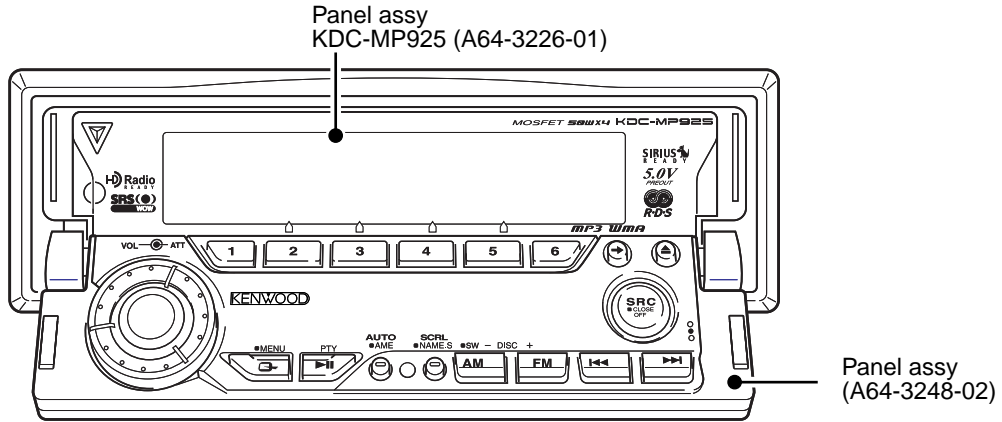

* DC cord
(E30-6295-05)

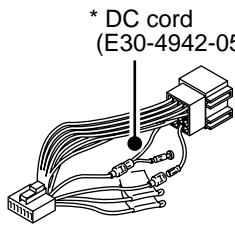

* DC cord
(E30-4942-05)

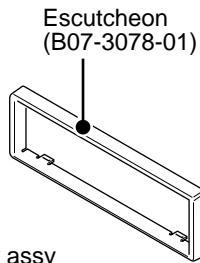

Escutcheon
(B07-3078-01)

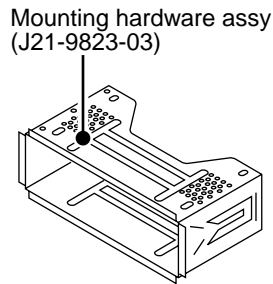

Mounting hardware assy
(J21-9823-03)

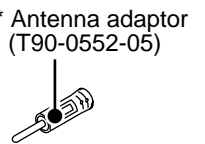

* Antenna adaptor
(T90-0552-05)

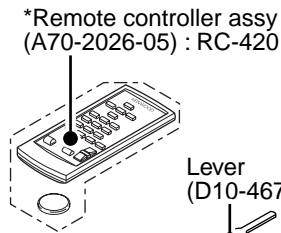

*Remote controller assy
(A70-2026-05) : RC-420

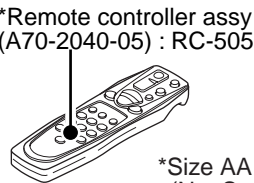

*Remote controller assy
(A70-2040-05) : RC-505

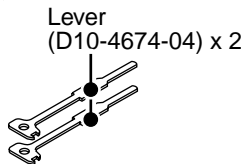

Lever
(D10-4674-04) x 2



*Size AA Battery
(Not Supplied)

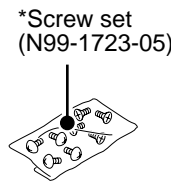

*Screw set
(N99-1723-05)



Screw
(N99-1734-05)

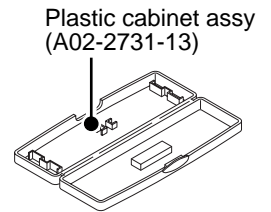

Plastic cabinet assy
(A02-2731-13)

TDF PANEL INFORMATION

MODEL	PARTS NO.	PANEL NAME
KDC-MP925	Y33-1790-61	TDF-M7000
KDC-W8027		

* Depends on model. Refer to the parts list.



BLOCK DIAGRAM

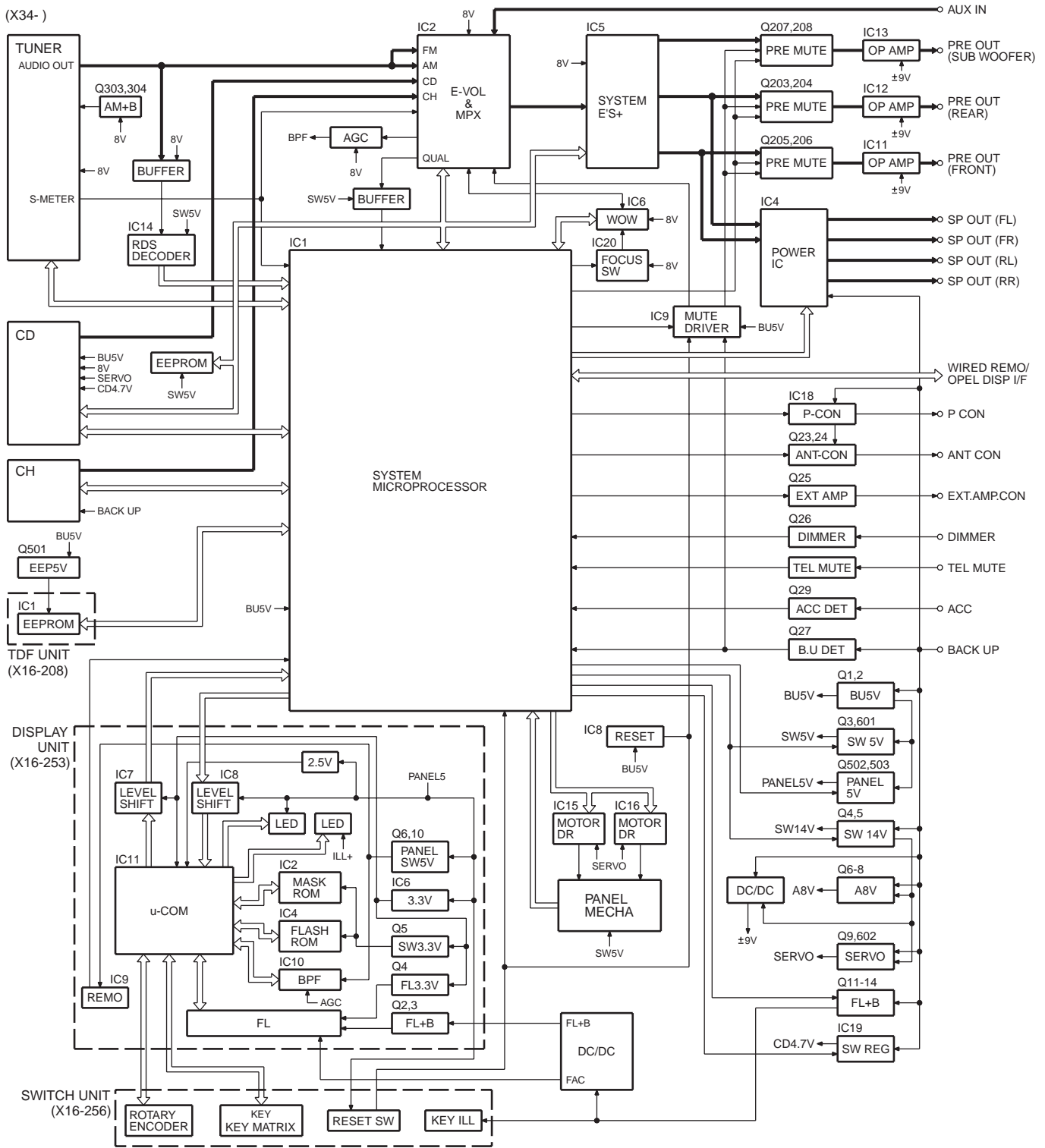

COMPONENTS DESCRIPTION

● SUB CIRCUIT UNIT (X16-2080-10)

Ref No.	Application / Functions	Operation / Condition / Compatibility
IC1	E2PROM	E2PROM for security

● DISPLAY UNIT (X16-2530-11)

Ref No.	Application / Functions	Operation / Condition / Compatibility
IC1	Panel microprocessor	Panel control microprocessor
IC2	ROM IC	Graphic ROM
IC4	AVR	For 3.3V power supply
IC5	AVR	For 2.5V power supply
IC6	Buffer IC	Level shift buffer IC (5V→3.3V)
IC7	Buffer IC	Level shift buffer IC (3.3V→5V)
IC8	Remote control IC	For Remote control sensor
IC9	Logic IC	Control for FL contrast
IC10	Analog IC	Spectrum analyzer IC
Q1	3.3V Regulator	While PAN5V is applied when 3.3V regulator output is +3.3V
Q2	2.5V Regulator	While PAN5V is applied when 2.5V regulator output is +2.5V
Q3,4	FL +B SW	FL +B (VDD1) is turned on when Q3 base level goes H
Q5	3.3V SW	SW3.3V is turned on when Q5 base level goes L
Q6,200	FL 3.3V SW	FL +3.3V (VDD1) is turned on when Q200 base level goes H
Q7,8	Remote control ON SW	The power supply of IC8, 10 is turned on when Q10 base level goes H
Q9	FL BLK SW	VFD is turned on when Q9 base level goes H
Q11	Red LED SW	Red LED is turned on when Q11 base level goes H

● SWITCH UNIT (X16-2560-10)

Ref No.	Application / Functions	Operation / Condition / Compatibility
Q1	DSI LED SW	DSI LED blinks when Q1 base level goes H/L
Q2	KEY Illumination SW (Green)	KEY Illumination SW "ON" when the Q2 base level goes H
Q3	KEY Illumination SW (Red)	KEY Illumination SW "ON" when the Q3 base level goes H
Q4	KEY Illumination SW (Blue)	KEY Illumination SW "ON" when the Q4 base level goes H

● CD PLAYER UNIT (X32-5540-00)

Ref No.	Application / Functions	Operation / Condition / Compatibility
IC1	Mechanism control microprocessor	-
IC2	DSP	CD signal processor, RF amp, Servo control
IC3	Decoder IC	MP3/WMA decoder
IC4	BTL driver	Focus, Tracking coil, Feed and Spindle motor driver IC
IC5	AVR	SW3.3V AVR
IC6	AVR	BU3.3V AVR
IC7	AVR	BU2.5V AVR
IC8	Selector IC	Serial audio data selector

COMPONENTS DESCRIPTION

Ref No.	Application / Functions	Operation / Condition / Compatibility
IC9	AVR	3.3V AVR (IC2 DAC part)
Q1,4	Level shift FET	Level shift (3.3V - 5.0V)
Q3,5	Level shift TR	Level shift (3.3V - 5.0V)
Q6	Level shift TR	Level shift (3.3V - 5.0V)
Q7	Level shift TR	Level shift (3.3V - 5.0V)
Q8	APC	Auto power control
Q9,10	Switching TR	Sub beam delay control switch

● ELECTRIC UNIT (X34-3030-10, X34-3032-71)

Ref No.	Application / Functions	Operation / Condition / Compatibility
IC1	System control IC	System control microprocessor
IC2	E-VOL & tuner IC	E-VOL. FM/AM tuner & stereo decoder
IC3	Power supply IC	For A8V AVR
IC4	Audio power IC	Audio power amplifier
IC5	System IC	For System E's control
IC6	Audio control IC	For WOW/FOCUS control
IC7	Power supply IC	-9V AVR (For 4.5V Pre-out)
IC8	Reset IC	When BU5V line voltage is less than 3.5V, this IC output line is "L"
IC9	Muting logic IC	Control for MUTE, P-ANT & RESET muting
IC10	Buffer IC	For spectrum analyzer
IC11~13	OP AMP	For 4.5V Pre-out
IC14	RDS decoder	Decode for RDS signal
IC15,16	Motor driver	Control for Panel mechanism motor
IC18	P-CON IC	Power control IC
IC19	Power supply IC	Switching regulator IC for CD4.7V
IC20	Analog SW	Control for WOW/FOCUS IC (IC4)
Q1,2	BU 5V AVR	While BU is applied when BU5V regulator output is +5V
Q3,601	SW5V AVR	When Q601 base level goes H, SW5V regulator output is +5V
Q4,5	SW14V AVR	When Q5 base level goes H, SW14V regulator output is +14V
Q6~8	Audio 8V AVR	When Q6 base level goes H, A8V regulator output is +8.3V
Q9,602	Servo +B AVR	When Q602 base level goes H, S+B regulator output is +7.5V
Q11~14	Illumination & DC/DC +B AVR	When Q11 base level goes H, AVR output is +9.2V
Q15,16	Audio 10.5V AVR	When Q16 base level goes H, AVR output is +10.5V
Q17~19	Pre Amp & -9V AVR	Q18,19 work as differential amplifier, Q17 work as driver and -9.1V is supplied to OP AMP for Pre-out
Q20~22	Pre Amp & +9V AVR	Q20,22 work as differential amplifier, Q21 work as driver and +9.4V is supplied to OP AMP for Pre-out
Q23,24	P-ANT SW	When Q23 base level goes H, P-ANT SW output is +14V
Q25	Buffer	EX amp control buffer
Q26	Small lamp det. SW	When Q26 base level goes H, Q26 turned ON

COMPONENTS DESCRIPTION

Ref No.	Application / Functions	Operation / Condition / Compatibility
Q27	BU detector	When Q27 base level goes H, Q27 turned ON
Q29	ACC detector	When Q29 base level goes H, Q29 turned ON
Q30,31	Muting driver	When base level goes L, muting driver is turned ON
Q201	Buffer	Noise detect buffer amp
Q202	E-VOL muting SW	When Q202 base level goes H, muting SW is turned ON
Q203~208	Pre-out muting SW	When base level goes H, Pre-output is muted
Q210	AGC	For AGC for spectrum analyzer
Q303,304	AM +B SW	When Q303 base level goes H, AM +B is out to tuner unit
Q305	Buffer	Composite signal buffer for RDS
Q501	E2P 5V SW	When Q501 base level goes L, E2P 5V is out for E2PROM
Q502,503	Panel 5V SW	When Q503 base level goes H, Panel 5V is out
Q603	SW	When Q603 base level goes H, Q603 is turned ON

MICROCOMPUTER'S TERMINAL DESCRIPTION

● SYSTEM MICROPROCESSOR : UPD703030GC041 (X34-303 : IC1)

Pin No.	Pin Name	I/O	Description / Processing Operation	Fig.
1	PLL DATA	I/O	Data input/output terminal for Tuner front-end	
2	AM+B	I/O	AM+B (AM operation : H)	
3	(FM+B)	O	FM+B (FM operation : H, Last FM : H with RDS, RBDS model)	
4	PAN E2P DATA	I/O	Variable illumination D/A converter, E2PROM DATA terminal	
5	PAN E2P CLK	I/O	Variable illumination D/A converter, E2PROM CLK terminal	
6	EVDD	-	VDD 5V	
7	EVSS	-	GND	
8	AFS	O	Time constant switching for noise detection (FM seek, AF search, AUTO 0 : L, Receiving : H)	
9	BEEP	O	BEEP audio output terminal	
10	REMO	I	Remote control input terminal	
11	P MUTE	O	Audio power IC muting control terminal (POWER OFF, ALL OFF, TEL MUTE : L)	
12	SVR	O	Audio power IC SVR discharge circuit control terminal	
13	IC2 SDA	I/O	CD mechanism, IC2, IC5, ROM correction DATA line	
14	IC2 CLK	I/O	CD mechanism, IC2, IC5, ROM correction CLOCK line	
15	P STBY	O	Audio power IC Stand-by terminal (POWER IC ON, ALL OFF : H, POWER IC OFF : L)	
16	P CON	I/O	Power control terminal (POWER ON : H, POWER OFF, ALL OFF : Hi-Z)	
17	WOW MODE2	O	WOW control terminal	1

MICROCOMPUTER'S TERMINAL DESCRIPTION

Pin No.	Pin Name	I/O	Description / Processing Operation	Fig
18	TEST	-	NC (GND)	
19	DIAG	I	Over voltage/Over current detection terminal (Normal : H, Bad condition : L)	
20	MUTE	O	MUTE output terminal (ON : OPEN, OFF : L)	
21	PRE MUTER	O	PREOUT (Rch) muting control terminal	
22	PRE MUTEL	O	PREOUT (Lch) muting control terminal	
23	BU DET	I	Momentary power dropped detection terminal (No Backup, Momentary power dropped : H, Backup : L)	
24	ACC DET	I	ACC detection terminal (With ACC : L, Without ACC : H)	
25	FOCUS	I/O	WOW/FOCUS control terminal (FOCUS HI : H, FOCUS LOW : L)	
26	EXT AMP CONT	O	External amplifier control terminal	
27	DIMMER	I	Small lamp detection terminal (ON : L, OFF : H)	
28	ANT CONT(TYPE2)	I/O	Antenna control/Destination select terminal (TUNER ON : H)	
29	P ON	I/O	SW14V, SW5V control terminal (POWER ON : H, POWER OFF : Hi-Z)	
30	ILL ON	I/O	FL, illumination control terminal (ON : H, OFF : Hi-Z)	
31	RESET	I	Reset input terminal	
32,33	XT1/XT2	-	Sub clock (32.768KHz)	
34	REGC	-	Connect to 1 μ F capacitor	
35,36	X2/X1	-	Main clock (20MHz)	
37	VSS	-	GND	
38	VDD	-	AVR 5V	
39	CLKOUT	-	NC	
40	LX REQ M	O	Communication request to external slave unit (Request : L)	
41	LX MUTE	I	Mute request from external slave unit (MUTE : H).	
42	LX CON	O	External slave unit (ON : H, OFF : L)	
43	LX RST	O	Reset output to external slave unit (Normal : L, After system reset : H 400ms or more and then L)	
44	CD MECHA+B	O	CD4.7V output terminal (CD : H, Except CD source : L)	
45,46	TYPE0/TYPE1	I	Destination select terminal	
47,48	IC2 TYPE0/TYPE1	I	IC2 destination select terminal	
49	PAN5V	O	Panel 5V control terminal (ON : H, Momentary power dropped : Hi-Z)	
50	E2P5V	I/O	E2PROM, D/A converter power supply control terminal (ON : L, OFF : Hi-Z)	
51	DSI	I/O	DSI control (ON : L, OFF : Hi-Z)	
52	MC REQ	O	Communication request to panel microprocessor	
53	PAN RST	O	Reset output to panel microprocessor (Normal : H, Reset, Momentary power dropped : L)	
54	WOW MODE3	O	WOW control terminal	1
55	DVDD	-	AVR 5V	
56	DVSS	-	GND	
57	SC CON	O	Panel microprocessor control terminal (POWER OFF, ACC OFF : L)	
58	M RST	O	Reset output to CD mechanism (Normal : H, Reset : L)	
59	M STOP	O	Stop request to CD mechanism (STOP : L, CD : H)	
60	CD SW3	I	CD DOWN SW detection terminal (CD disc chucking : H)	
61	LO/EJ	I/O	CD mechanism loading/ eject selector (STOP, Brake : Hi-Z, LOADING : L, EJECT : H)	

MICROCOMPUTER'S TERMINAL DESCRIPTION

Pin No.	Pin Name	I/O	Description / Processing Operation	Fig
62	MOSW	O	CD mechanism motor driver SW (LOADING, EJECT, Brake : H)	
63	FPM MOTOR B	O	FPM mechanism (Slider) control terminal	2
64	FPM MOTOR F	O	FPM mechanism (Slider) control terminal	2
65	FPM MOTOR O	O	FPM mechanism (Angle) control terminal	2
66	FPM MOTOR C	O	FPM mechanism (Angle) control terminal	2
67	O DATA	I/O	External display DATA terminal	2
68	O CLK	I/O	External display CLK terminal	
69	O CE	I/O	External display chip enable terminal	
70	M MUTER	I	Mute request from CD mechanism (Rch ON : L)	
71	AVDD	-	AVR 5V	
72	AVSS	-	GND	
73	AVREF	I	Connect to P-ON (29PIN)	
74	M MUTEL	I	Mute request from CD mechanism (Lch ON : L)	
75	PAN DET	I	PANEL, E2PROM detection terminal (With panel : L, Without : H)	
76	PHONE	I	PHONE detection terminal (TEL MUTE : 1V or less, NAVI MUTE : 2.5V or more)	
77	FPM SW4	I	FPM mechanism position detect/ CD Mechanism detection terminal (3.75V or more : No mechanism, 1.25V or more : H, Less than 1.25V : L)	2
78	FPM SW1	I	FPM mechanism position detect terminal	2
79	FPM SW2	I	FPM mechanism position detect terminal	2
80	FPM SW3	I	FPM mechanism position detect terminal	2
81	FPM PHOUT	I	FPM mechanism position detect terminal (2.2V or more : H)	2
82	S METER	I	S meter detection terminal	
83	NOISE	I	FM noise detection terminal	
84	IFC OUT	I	Front end IFC OUT input terminal (Receiving station : 2.5V or more)	
85	POWER DET	I	Audio power IC DC offset detection	
86	CD SW4	I	8cmDISC detection terminal (8cmDISC : L)	
87	R CLK	I	RDS decoder clock input terminal	
88	LX REQ S	I	Receive request from external slave unit (Request : L)	
89	SC REQ	I	Communication request from panel microprocessor	
90	CD SW1	I	LOADING SW detection terminal (LOADING start, POWER OFF : L)	
91	CD SW2	I	12cmDISC detection terminal (12cmDISC, POWER OFF : L)	
92	R QUAL	I	RDS decoder QUAL input terminal	
93	R DATA	I	RDS decoder DATA input terminal	
94	LX DATA S	I	Data input from external slave unit	
95	LX DATA M	O	Data output to external slave unit	
96	LX CLK	I/O	Clock input/ output with external slave unit	
97	PAN RX	I	Data input from panel microprocessor	
98	PAN TX	O	Data output to panel microprocessor	
99	WOW MODE1	O	WOW control terminal	
100	PLL CLK	I/O	Clock input/ output to Tuner front-end	1

KDC-MP925/W8027

MICROCOMPUTER'S TERMINAL DESCRIPTION

Fig.1 WOW mode operation

MODE	WOW MODE1	WOW MODE2	WOW MODE3	FOCUS
BYPASS	L	L	L	Don't care
TuBass	L	H	L	Don't care
3D-STEREO	L	L	H	Don't care
FOCUS LOW	H	L	L	L (Hi-Z)
FOCUS HI	H	L	L	H
WOW LOW	H	H	H	L (Hi-Z)
WOW HI	H	H	H	H

Fig.2 FPM motor control

SLIDE		FPM mechanism operation	ANGLE		FPM mechanism operation
FPM MOTOR B	FPM MOTOR F		FPM MOTOR O	FPM MOTOR C	
L	L	Standby	L	L	Standby
H	L	Backward operation	H	L	Angle open direction
L	H	Forward operation	L	H	Angle close direction
H	H	Brake	H	H	Brake

● **PANEL MICROPROCESSOR : 703132GJ011-A (X16-253 : IC1)**

Pin No.	Pin Name	I/O	Description / Processing Operation
1~7	D14~D8	I/O	External ROM data input/output terminal
8	3.3VDD	-	AVR 3.3V
9	VSS	-	GND
10~17	D7~D0	I/O	External ROM data input/output terminal
18	FL GCP1	O	FL bright control terminal
19	SC REQ	O	Communication request to system microprocessor (H : Request)
20	MC REQ	I	Request from system microprocessor (H : Request)
21	SC CON	I	Panel microprocessor control (H : While operation)
22	FL BLK	O	Display control SW for FL driver (H : Display ON, L : Display OFF)
23	2.5V VDD	-	AVR 2.5V
24	VSS	-	GND
25~27	KS5~KS3	O	Key scan output terminal
28,29	TDI/TDO	-	NC
30,31	KS2,1	O	Key scan output terminal
32	TRST	I	NC
33	ROTARY CCW	I	Volume input terminal
34	ROTARY CW	I	Volume input terminal
35,36	TMS/TCM	O	NC
37	3.3VDD	-	AVR (3.3V)

MICROCOMPUTER'S TERMINAL DESCRIPTION

Pin No.	Pin Name	I/O	Description / Processing Operation
38	VSS	-	GND
39~42	KI1~KI4	I	Key return input terminal
43	FLGCP2	O	FL bright control terminal
44	NC	-	NC
45	SYS TX	I	DATA input from system microprocessor
46	SYS RX	O	DATA output to system microprocessor
47	FL CLK3	O	Clock output to FL driver
48	KI5	I	Key return input terminal (SRC, OPEN, EJECT interrupt port)
49	FL DATA3	O	DATA output to FL driver
50	SCK1	I	Clock input from FL driver
51	NC	-	NC
52	FL DATA2	O	DATA output to FL driver
53	CLK IN1	I	Clock input from FL driver
54	NC	-	NC
55	FL DATA1	O	DATA output to FL driver
56	3.3VDD	-	AVR (3.3V)
57,58	X2/X1	-	Main clock (5MHz)
59~61	CVSS/CKSEL/PSEL	-	GND
62	2.5V VDD	-	AVR 2.5V
63	VSS	-	GND
64,65	MODE0,1	-	GND
66	PAN RST	I	Reset signal request form system microprocessor (L : Reset)
67	VREF	-	Connect to 83PIN (VREF)
68,69	NC	-	NC
70,71	AVSS1,0	-	GND
72	VREF	-	Connect to 83PIN (VREF)
73	WAVE IN	I	Audio signal input terminal
74	F06	I	Spectrum analyzer input terminal (BPF 10KHz)
75	F05	I	Spectrum analyzer input terminal (BPF 3.3KHz)
76	F04	I	Spectrum analyzer input terminal (BPF 1KHz)
77	F03	I	Spectrum analyzer input terminal (BPF 330Hz)
78	F02	I	Spectrum analyzer input terminal (BPF 150Hz)
79	F01	I	Spectrum analyzer input terminal (BPF 63Hz)
80	NC	-	NC
81	2.5V VDD	-	AVR 2.5V
82	VSS	-	GND
83	VREF CON	O	VREF control terminal (Connect to VREF terminal)
84	NC	-	NC
85	FLGCP3	O	FL bright control terminal
86	NC	-	NC

KDC-MP925/W8027

MICROCOMPUTER'S TERMINAL DESCRIPTION

Pin No.	Pin Name	I/O	Description / Processing Operation
87	FL LATCH	O	Latch output to FL driver IC
88,89	NC	-	NC
90	REMO ON	O	Power supply control for remote control IC (H : ON, Hi-Z : OFF)
91	FL3.3V SW	O	FL3.3V control terminal (H : ON, Hi-Z : OFF)
92	FL+B SW	O	FL+B control terminal (H : ON, Hi-Z : OFF)
93	3.3V SW	O	3.3V control terminal (L : ON, Hi-Z : OFF)
94	NC	-	NC
95	OE	O	OE control for Flash ROM (L : DATA transmission, Hi-Z : Wait ready)
96	NC	-	NC
97	WE/WR	O	WRITE/READ control for Flash ROM (L : Writing, Hi-Z : Wait ready)
98	3.3V VDD	-	AVR 3.3V
99	EVSS	-	GND
100	CE ROM	O	CE control for ROM (L : DATA transmission, Hi-Z : Wait ready)
101	CE F/ROM	O	CE control for Flash ROM (L : DATA transmission, Hi-Z : Wait ready)
102	FLASHROM CHECK	O	Writing condition check for Flash ROM (H : OK, L : NG)
103,104	NC	-	NC
105	GREEN LED	O	Select for illumination (GREEN H : ON, L : OFF)
106	RED LED	O	Select for illumination (RED H : ON, L : OFF)
107	DISP LED	O	DISP LED control (Normal H : ON, L : OFF)
108	BLACK DISP	O	Light up to DISP LED (H : ON, L : OFF)
109,110	NC	-	NC
111	SA RST	O	Reset for spectrum analyzer (H : Reset, L : Normal)
112	3.3V VDD	-	AVR 3.3V
113	EVSS	-	GND
114~117	NC	-	NC
118~123	A21~A16	O	Address bus
124	2.5V VDD	-	AVR 2.5V
125	VSS	-	GND
126~133	A15~A8	O	Address bus
134	3.3V VDD	-	AVR 3.3V
135	EVSS	-	GND
136~143	A7~A0	O	Address bus
144	D15	I/O	External ROM data input/output terminal

TEST MODE

● How to enter the test mode

While pressing and holding the Preset 1 and Preset 3 keys, reset the unit.

● How to exit from the test mode

While holding the Preset 6 key, reset the unit.

Note : Turning ACC off, power off, momentary power down or panel detaching does not terminate the test mode.

● Initial status in the test mode

- Sources : ALL OFF
- Display : All segments are lit.
- Volume : -10dB (displayed as "30")
- Loudness : OFF
- CRSC : OFF regardless of the presence of switching function.
- SYSTEM Q : Flat
- WOW : All OFF
- BEEP : When pressing any keys, the buzzer generates a beep at any time.
- AUX : ON
- MENU SYSTEM Q : OFF
- Variable model : Default is white
- Multifunction : Source dependency (Preset, SCAN, etc.)

● Special display in Tuner mode

When any of the following messages is displayed in Tuner mode, the F/E may be abnormal.

- "TNE2P NG" : The EEPROM is set to the default (unstable values) because the F/E was shipped without passing through the adjustment process, etc.
- "TNCON NG" : Communication with the F/E is not possible.

● Forced switching of K3I

Each press of the Preset 6 key in Tuner mode should switch K3I from AUTO→Forced Wide→Forced Middle→Forced Narrow→AUTO.

The initial status is AUTO and the display shows these modes as follows.

- AUTO : FMA
- Forced Wide : FMW
- Forced Middle : FMM
- Forced Narrow : FMN

● Test mode specifications of the CD receiver

- Forced ejection is inhibited in the reset start operation. When the unit is reset while a CD is loaded in it, resetting does not recognize the CD.
- Each press of the Track Up key jumps to the following track numbers :
No. 9→No. 15→No. 10→No. 11→No. 12→No. 13→No. 22→No. 14→No. 9 (The cycle restarts from here.)
- Each press of the Track Down key jumps to the previous track number to the track being played.
- When the number of total tracks of the MP3 disc or the WMA disc is less than 9, 1st track is played.
- When the disc media is CD, A short press of the Preset 1 key jumps to the track number 28.
- When the model is equipped the CD mechanism assembly adapted for MP3 or MP3/WMA disc, the mechanism name and version number are displayed during the FL model is lower stand and Display mode of LCD model is DNPS.

● Audio-related specifications

- Pressing the * key on the remote initiates the audio adjustment mode.
- BL/F key on the Fader initials.
- Continuous holding of a remote control key is inhibited, and workings are short press of any keys.
- Bass, Middle and Treble are adjusted in 3 steps of -8 / 0 / +8 with the Track Up/Down keys (Default value at 0).
- Balance is adjusted in 3 steps of L15 / 0 / R15 with the Track Up/Down keys (Default value at 0).
- Fader is adjusted in 3 steps of R15 / 0 / F15 with the Track Up/Down keys (Default value at 0).
- HPF is adjusted in 2 steps of OFF / 170Hz (or 200Hz) with the Track Up/Down keys (Default value at OFF).
- LPF is adjusted in 2 steps of OFF / 120Hz with the Track Up/Down keys (Default value at OFF).
- Bass f, Bass Q, Bass EXT, Middle f, Middle Q and Treble f are not dealt with by the audio adjust.
- The WOW key passes during the audio adjustment as following steps (WOW model only).

Ordered	TruBass	FOCUS	SRS	Display
1	OFF	OFF	OFF	SRS WOW OFF
2	ON	OFF	OFF	SRS TruBass ON
3	OFF	LOW	OFF	FOCUS LOW
4	OFF	HIGH	OFF	FOCUS HIGH
5	OFF	OFF	ON	SRS ON
6	ON	HIGH	ON	SRS WOW HIGH

TEST MODE

● Menu-related specifications

- A short press of the Q key initiates the menu mode.
- Pressing the DNPP key on the remote initiates the Menu mode.
- Continuous holding of a remote control key is inhibited, and workings are short press of any keys.
- Contrast is adjusted in 3 steps of 0 / 5 / 10 with the Track Up/Down keys (Default value at 5).

● Backup current measurement

When the unit is reset while ACC is OFF (i.e. by turning Backup ON), the MUTE terminal goes OFF in 2 seconds in place of 15 second. (The CD mechanism is not activated at this time.)

● Special display when the display is all on

Pressing the Preset keys while the power is ALL OFF displays the following information.

[PRESET 1]	Version display (8 digits, Month/Day/Hour/Minute) (Display) SYS xxxxxxxx : PAN xxxxxxxx : FL model only MEM xxxxxxxx : 4 contrasts FL model only
[PRESET 2]	Serial number display (8 digits) (Display) SNo xxxxxxxx
[PRESET 3]	Short press : View power ON time. (The All OFF period is not counted.) 2 seconds long press/hold : Clear power ON time at the power ON time displaying. (Display) PonTim xxxxx Max. 60000 (hours)
[PRESET 4]	Short press : Display CD operation time. 2 seconds long press/hold : Clear CD operation time at the CD operation time displaying. (Display) CDTim xxxxx Max. 60000 (hours)
[PRESET 5]	Short press : Display CD ejection count. 2 seconds long press/hold : Clear CD ejection count at the CD ejection count displaying. (Display) EjeCnt xxxxx Max. 60000 (times)
[PRESET 6]	Short press : Display Panel open/close count. 2 seconds long press/hold : Clear Panel open/close count at the Panel open/close count. (Display) PnCnt xxxxxx Max. 600000 (times)
FM key	Display ROM collection version. (Display) ROM R xxx Invalid : "R ---"

AM key	Display panel E2PROM condition. (Display) P-ROM OK (Registered code) P-ROM NG (Code is write in error) P-ROM WAIT (Unregistered code) P-ROM NON (Panel security nonfunctional)
--------	--

● Panel mechanism

- Auto-panel close inhibition when set-in the CD.
- The panel operation inhibition at power ON/OFF and ACC ON/OFF.
- The panel position changing Eject→Last with a short press of the PLAY/PAUSE keys.

● Other specifications

- No displays such as "CODE OFF/ON" during Power-ON.
- The LINE MUTE inhibition time is one second from 10 seconds when start-up the test mode.
- Do not write the security code with the security jig on the test mode.
- Do not write the serial with the serial writing jig on the test mode.
- OEM display output is not stop if OEM display not connection on the test mode.

● Switching the frequency span (K/M type)

While holding the Preset 1 key and Preset 5 key, reset the unit.

● Demonstration mode

1. How to enter to the Demonstration mode

1. Hold down the [Q] key and [TI (AME)] key button when the power is on and press the Reset button.
2. This will enter to the Demonstration mode.

2. How to cancel the Demonstration mode

1. Hold-down the Preset [5] key button when the power is on and press the Reset button.
2. This will cancel the Demonstration mode.

TEST MODE

● Security information

1. Forced Power ON mode (All models)

Even when the security (Cord) is approved, resetting the unit while holding the Q and Preset 4 keys makes it possible to turn the power ON for 30 minutes.

After 30 minutes have elapsed, it is not possible to return to the previous condition unless the unit is reset again. (Security code is doing not clear at this mode. Put the power on fill-in.)

When panel security was set up for the unit when it is can not power on.

In this case, you can use new ROM for the TDF panel that the unit can be power on for test mode.

Note : Don't enter the panel security set up for new ROM panel. User can not power on the unit.

2. Method of registration of the security code after EEPROM (F/E) replacement (Code security model)

1. Enter the test mode. (See How to enter the test mode)
2. Press the MENU key to enter the Menu mode.
3. When the message "Security" is displayed, press and hold the Track Up/Down key for 1 second to enter the security registration mode.
4. Enter the code using the FM/AM/Track Up/Track Down keys.
FM key : Number up
AM key : Number down
Track Up key : Cursor right shift
Track Down key : Cursor left shift
5. Hold down the Track Up key for at least 3 seconds and the message, "RE-ENTER" appears, so once again enter the code according to Step 4 above.
6. Press and hold the Track Up key for 3 seconds until "APPROVED" is displayed.
7. Exit from the test mode. (See 2. How to exit from the test mode)

Note 1 : All Clear is not applicable to the security code of this model.

Note 2 : When the F/E changed, need re-inscription because the panel security is clear.

3. How to inscription the panel security code

1. Enter the test mode.
2. Pressing the AM key on all lighting, check the "P-ROM WAIT" display.
3. The NEXT key is long press 2 seconds, writing the code.
4. Display is "P-ROM OK".
5. Exit from the test mode.

Note : E2PROM connection is NG when display is "P-ROM NG", so detach the panel and rewrite after the display is "PROM WAIT". This code can not clear.

4. Simple way to clear the security code (K type only)

1. During code request mode, press the Track UP key for at least 3 seconds while holding down the AUTO key. (--- will disappear)
2. Enter, "KCAR" with the remote controller as described below.
 - Press the remote controller 5 key twice, and press the Track Up key. (Enters a "K")
 - Press the remote controller 2 key three times, and press the Track Up key. (Enters a "C")
 - Press the remote controller 2 key once, and press the Track Up key. (Enters an "A")
 - Press the remote controller 7 key twice, and press the Track Up key. (Enters an "R")
3. Security function is canceled and unit sets to All-Off mode.
4. Code request mode appears if a mistake was made in entering the numbers.

A B C D E
1
2
3
4
5
6
7
KDC-MP925/W8027
PC BOARD (COMPONENT SIDE VIEW)

ELECTRIC UNIT X34-3030-10, X34-3032-71 (J74-1473-32)

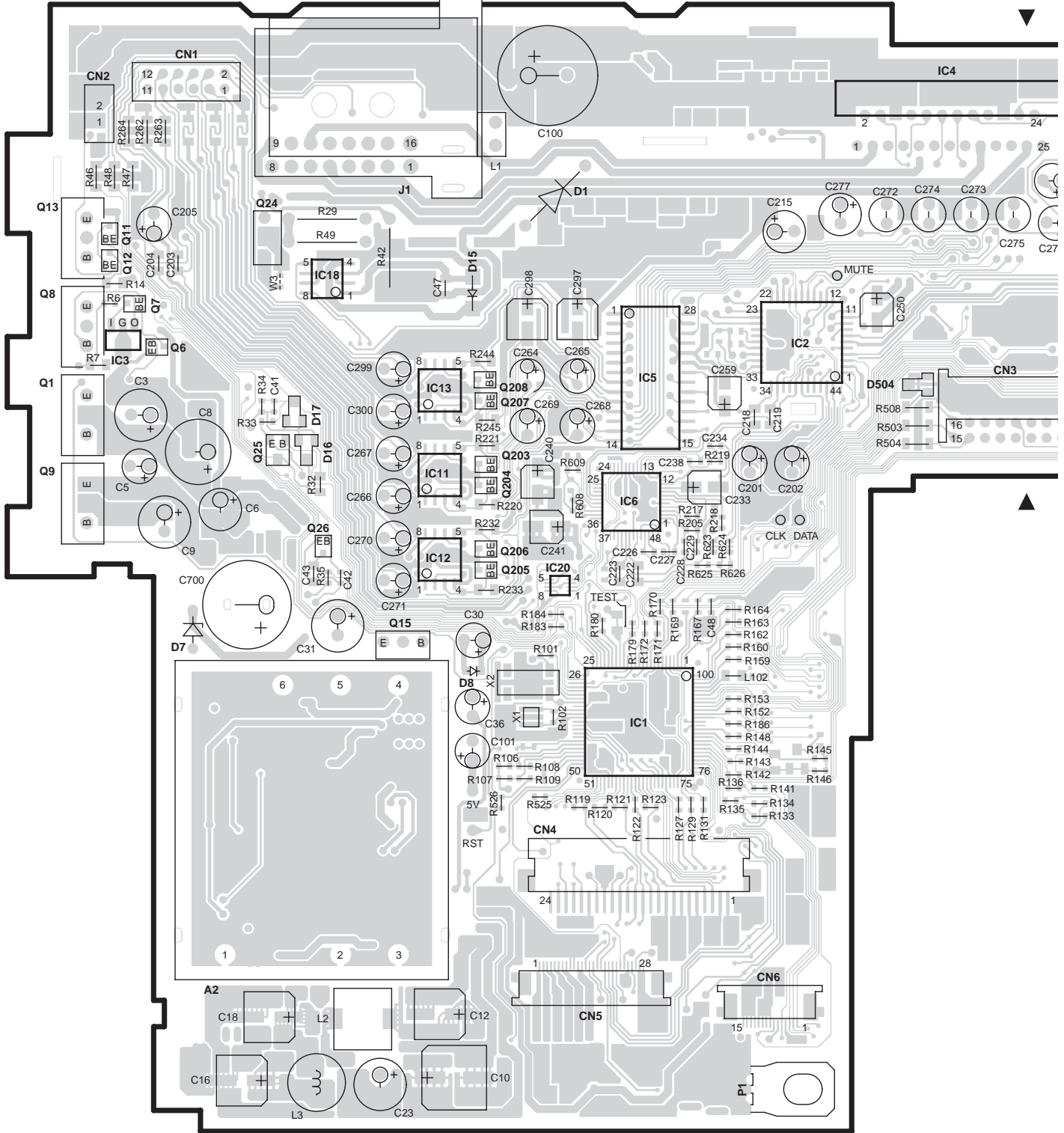

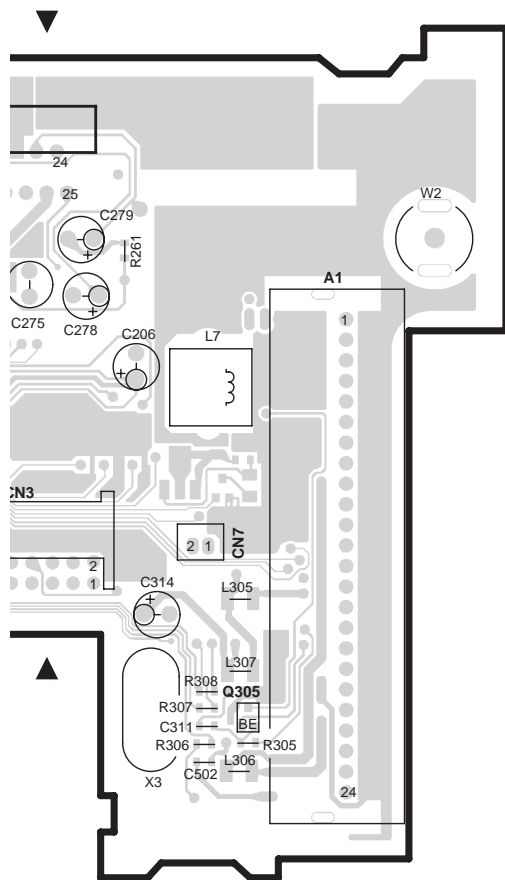

X34-303x-xx

Ref. No.	Address	Ref. No.	Address
IC1	5D	Q9	3A
IC2	3D	Q11	2A
IC3	3A	Q12	3A
IC4	2E	Q13	2A
IC5	3D	Q15	4C
IC6	4D	Q24	2B
IC11	3C	Q25	3B
IC12	4C	Q26	4B
IC13	3C	Q203	3C
IC18	3B	Q204	4C
IC20	4C	Q205	4C
Q1	3A	Q206	4C
Q6	3A	Q207	3C
Q7	3A	Q208	3C
Q8	3A	Q305	4F

Refer to the schematic diagram for the values of resistors and capacitors.

DISPLAY UNIT
X16-2530-11 (J74-1587-02)

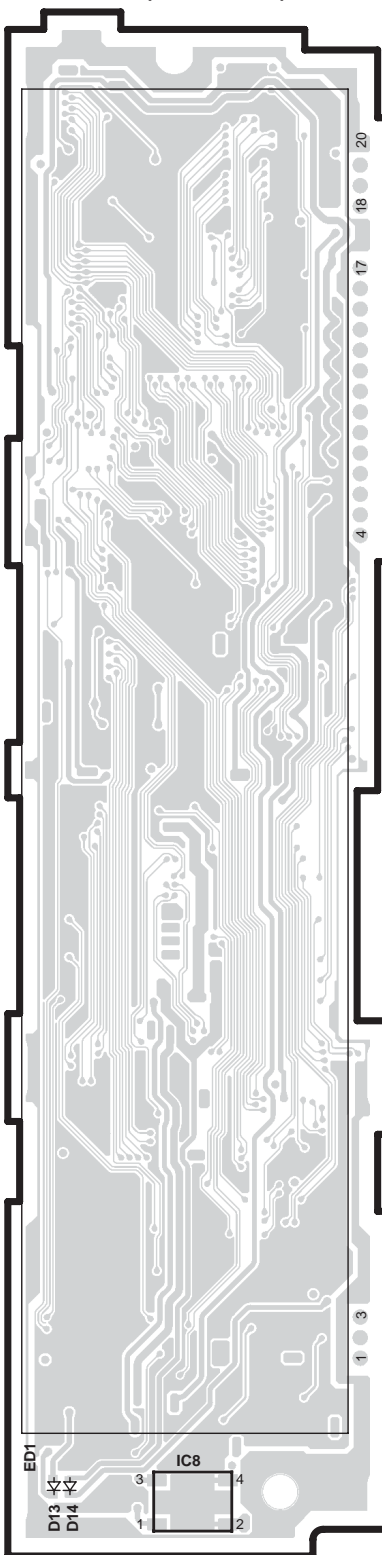

X16-2530-11

Ref. No.	Address
IC8	6H

SWITCH UNIT
X16-2560-10 (J74-1590-02)

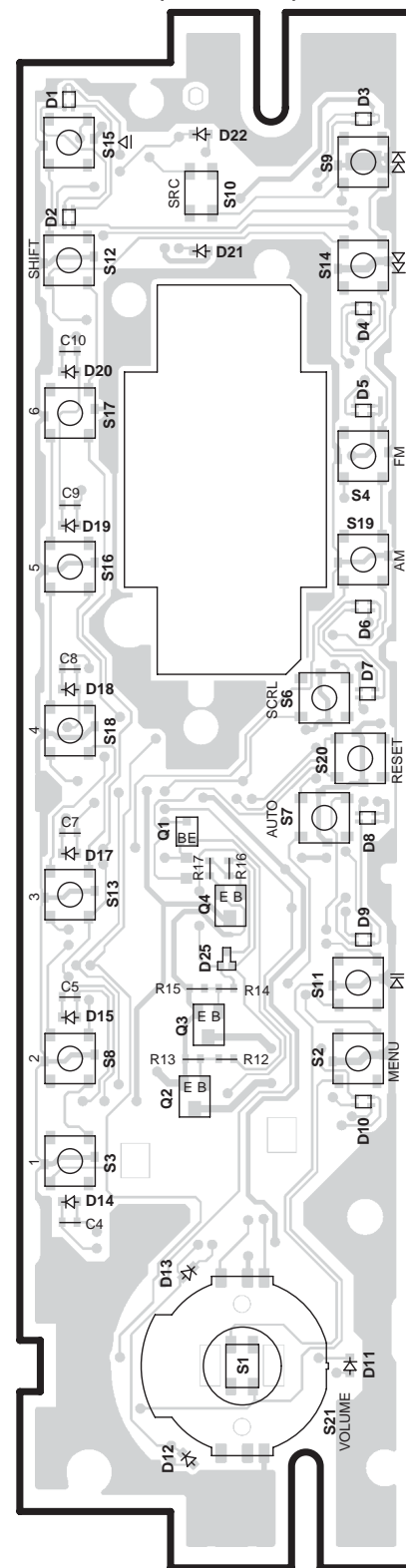

X16-2560-10

Ref. No.	Address	Ref. No.	Address
Q1	4I	Q3	5I
Q2	5I	Q4	4J

KDC-MP925/W8027 PC BOARD (FOIL SIDE VIEW)

ELECTRIC UNIT X34-3030-10, X34-3032-71 (J74-1473-32)

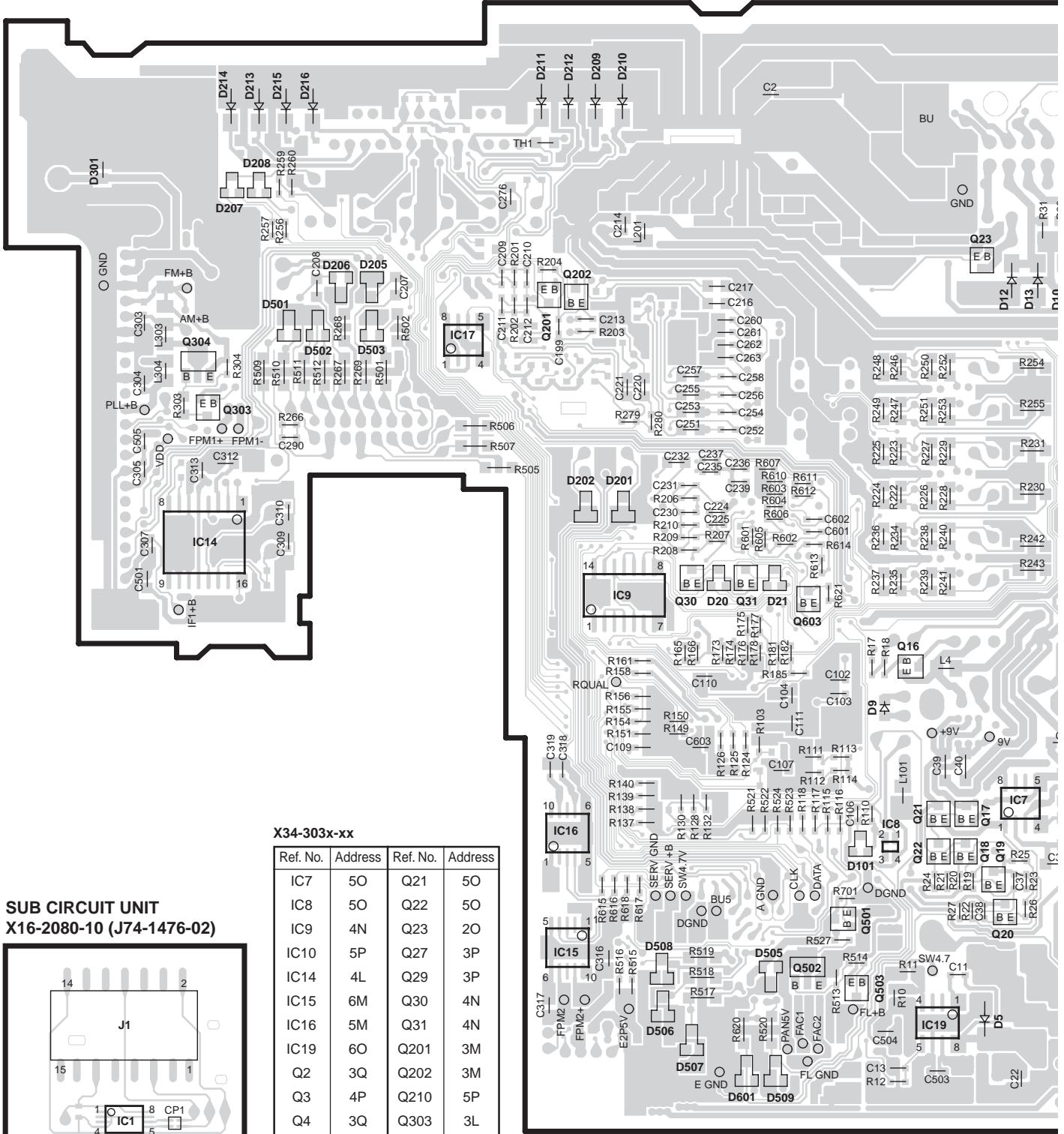

SUB CIRCUIT UNIT X16-2080-10 (J74-1476-02)

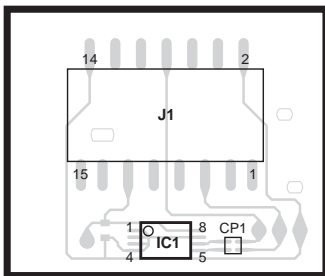

X16-2080-10

Ref. No.	Address
IC1	6K

X34-303x-xx

Ref. No.	Address	Ref. No.	Address
IC7	50	Q21	50
IC8	50	Q22	50
IC9	4N	Q23	20
IC10	5P	Q27	3P
IC14	4L	Q29	3P
IC15	6M	Q30	4N
IC16	5M	Q31	4N
IC19	60	Q201	3M
Q2	3Q	Q202	3M
Q3	4P	Q210	5P
Q4	3Q	Q303	3L
Q5	3Q	Q304	3L
Q14	3Q	Q501	50
Q16	40	Q502	6N
Q17	50	Q503	60
Q18	50	Q601	3P
Q19	50	Q602	4Q
Q20	60	Q603	4N

Refer to the schematic diagram for the values of resistors and capacitors.

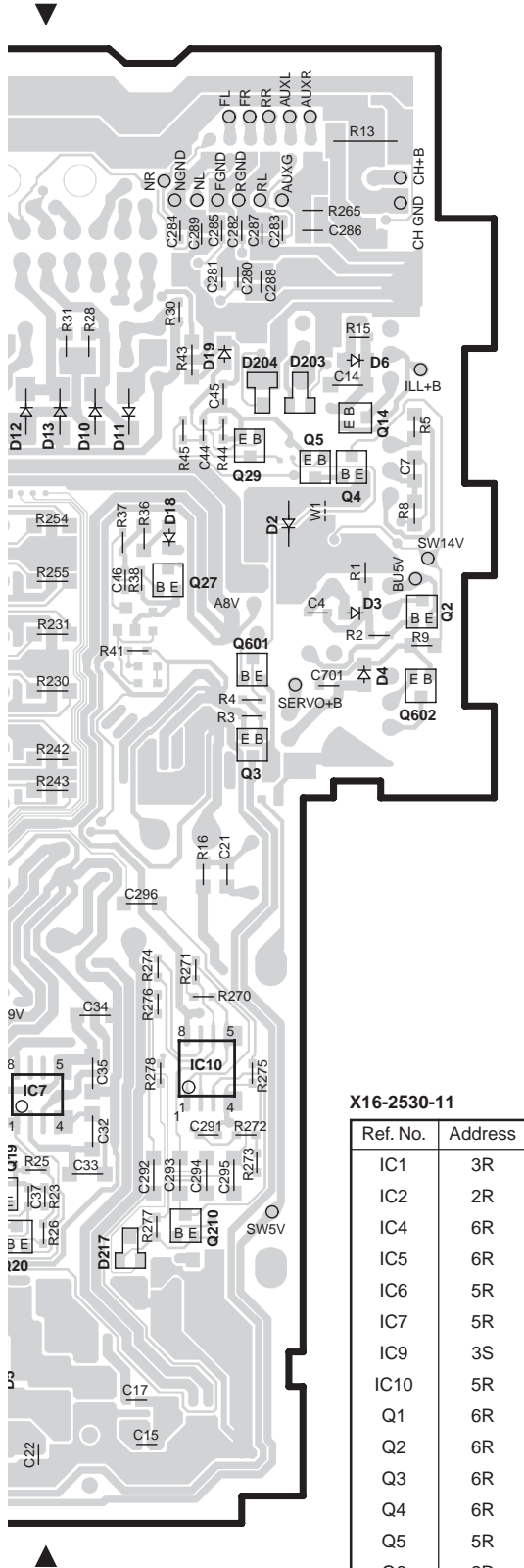

X16-2530-11

Ref. No.	Address
IC1	3R
IC2	2R
IC4	6R
IC5	6R
IC6	5R
IC7	5R
IC9	3S
IC10	5R
Q1	6R
Q2	6R
Q3	6R
Q4	6R
Q5	5R
Q6	2R
Q7	6R
Q8	6S
Q9	2R
Q11	6R
Q200	2S

DISPLAY UNIT
X16-2530-11 (J74-1587-02)

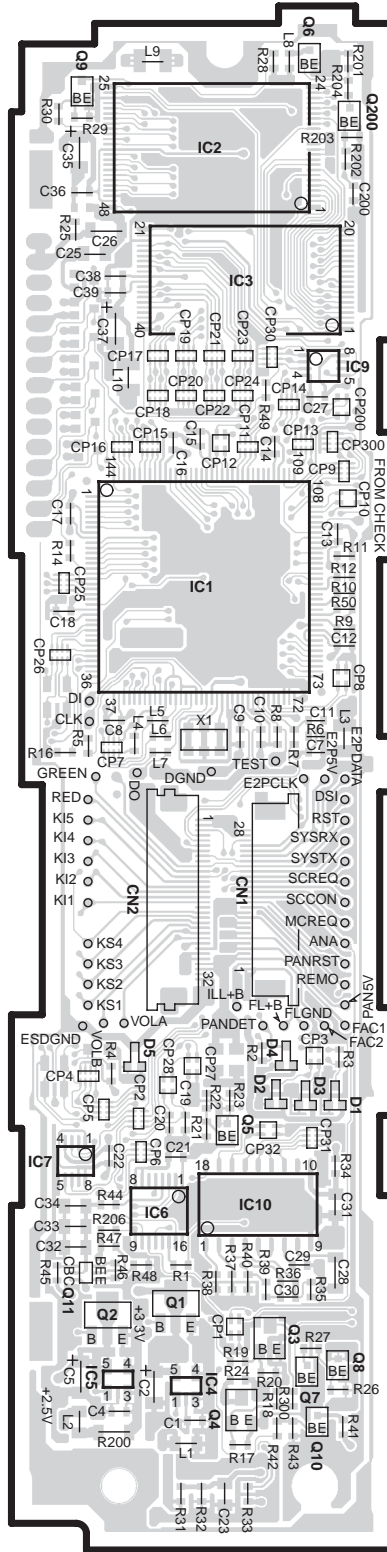

SWITCH UNIT
X16-2560-10 (J74-1590-02)

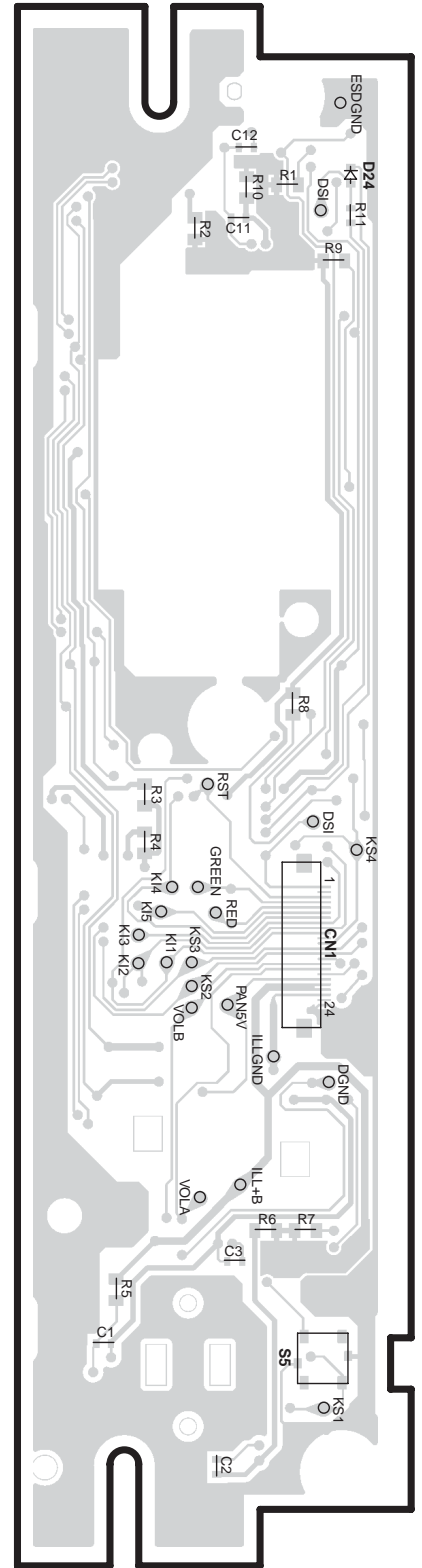

PC BOARD (COMPONENT SIDE VIEW)

CD PLAYER UNIT X32-5540-00 (J74-1552-12)

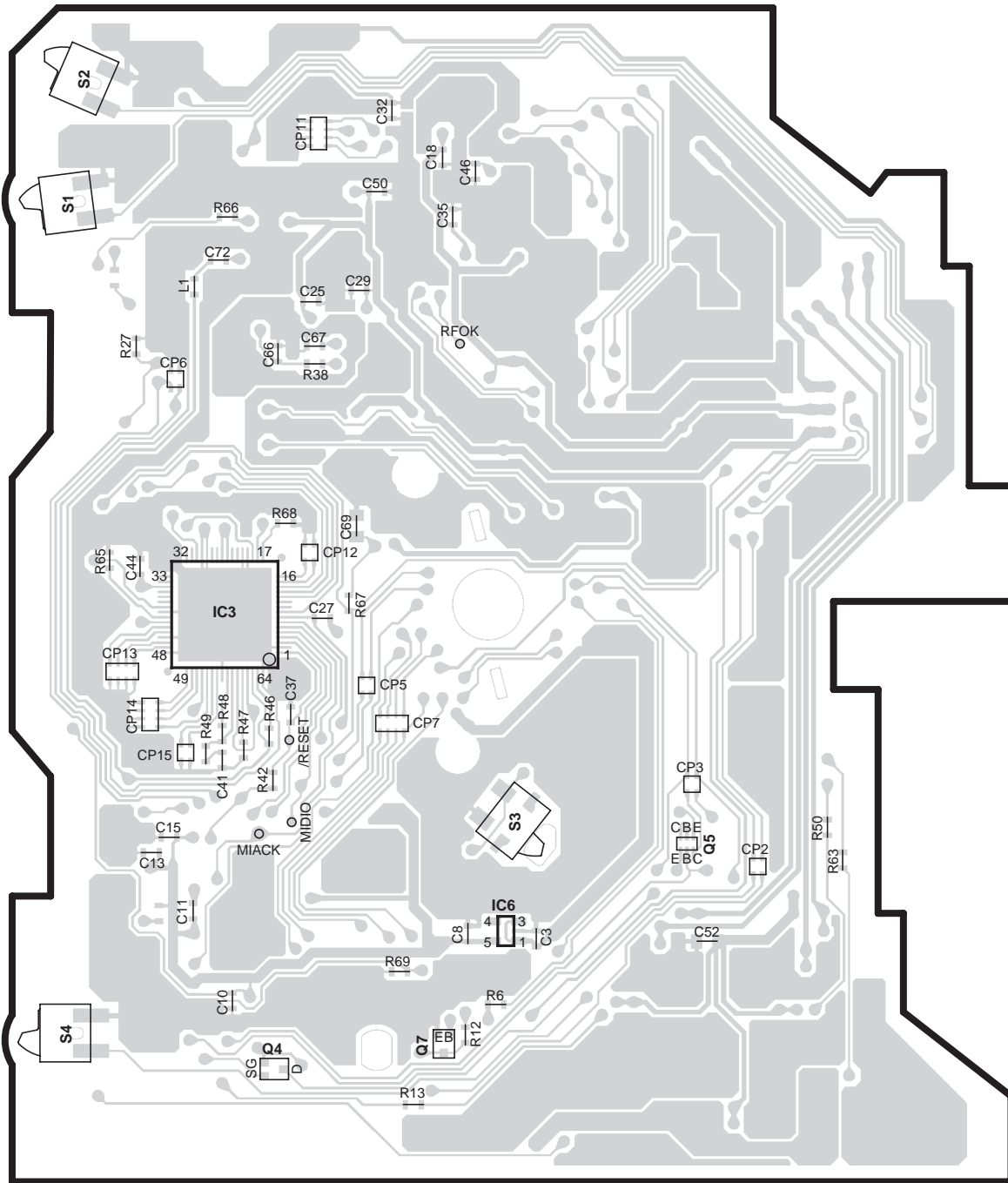

X32-5540-00

Ref. No.	Address
IC3	4V
IC6	5W
Q4	5V
Q5	5X
Q7	5W

Refer to the schematic diagram for the values of resistors and capacitors.

PC BOARD (FOIL SIDE VIEW)

CD PLAYER UNIT X32-5540-00 (J74-1552-12)

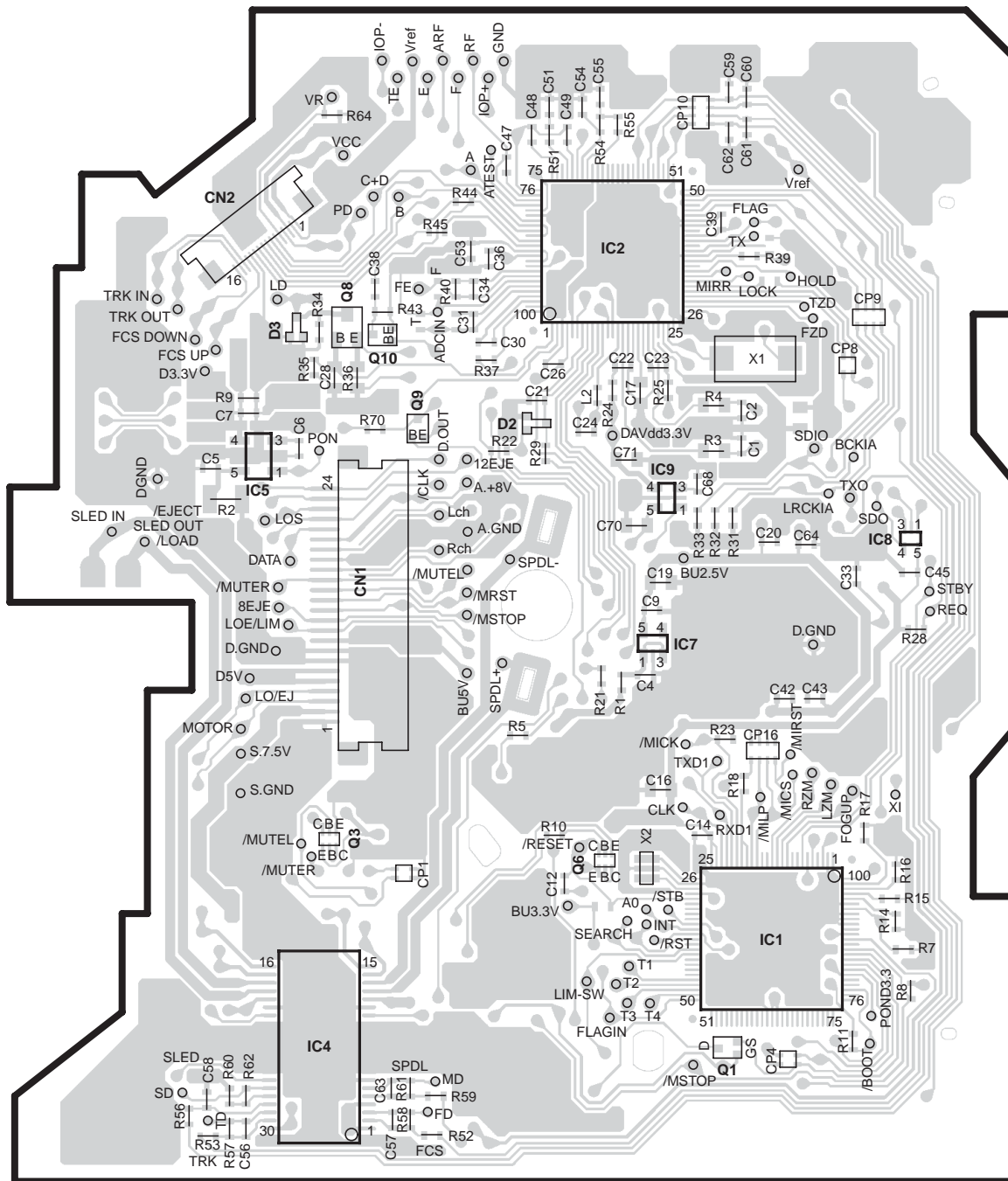

X32-5540-00

Ref. No.	Address	Ref. No.	Address
IC1	5AC	Q1	5AC
IC2	2AB	Q3	5AA
IC4	5AA	Q6	5AB
IC5	3AA	Q8	2AA
IC7	4AB	Q9	3AA
IC8	3AC	Q10	3AA
IC9	3AB		

Refer to the schematic diagram for the values of resistors and capacitors.

KDC-MP925/W8027

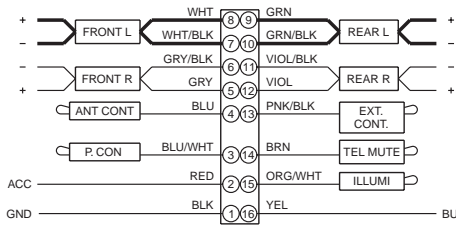

DC CORD
(E30-6294-05) : KDC-X879

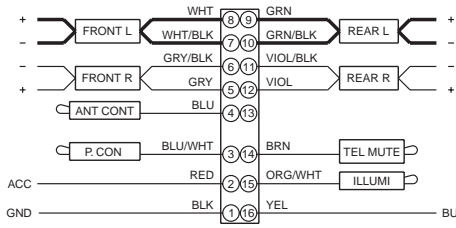

DC CORD
(E30-6295-05) : KDC-MP925

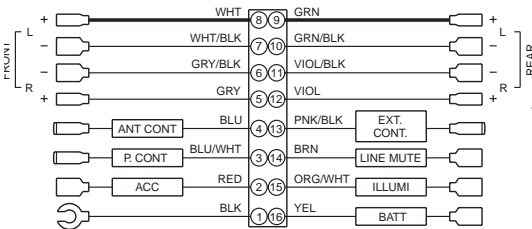

DC CORD
(E30-6061-05) : FX-9100

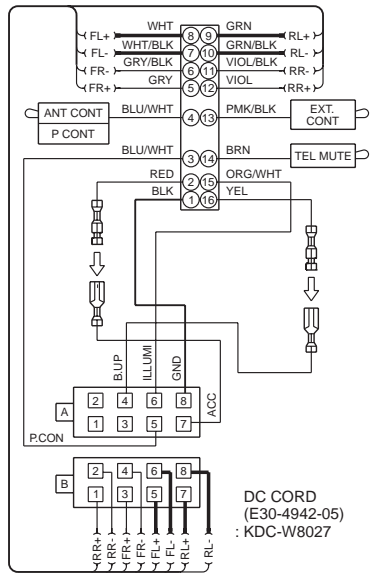

DC CORD
(E30-4942-05)
: KDC-W8027

(X34-303x-xx)

MODEL NAME	UNIT No.	A	B	C	D	E	F	G	H	I	A1	C100	C250	C259
KDC-MP925	0-10	YES	YES	YES	YES	NO	NO	NO	NO	NO	X86-3730-11	C90-5624	C92-0687	C92-0686
KDC-X879	0-11	YES	YES	YES	YES	NO	NO	NO	NO	NO	X86-3730-11	C90-5626	CE32AT1H2R2M	CE32AT1H010M
FX-9100	0-01	YES	NO	NO	NO	NO	NO	NO	NO	NO	X86-3730-01	C90-5626	CE32AT1H2R2M	CE32AT1H010M
KDC-W8027	2-71	NO	NO	NO	NO	NO	NO	NO	NO	NO	X86-3732-70	C90-5626	CE32AT1H2R2M	CE32AT1H010M

ELECTRIC UNIT (X34-303x-xx)

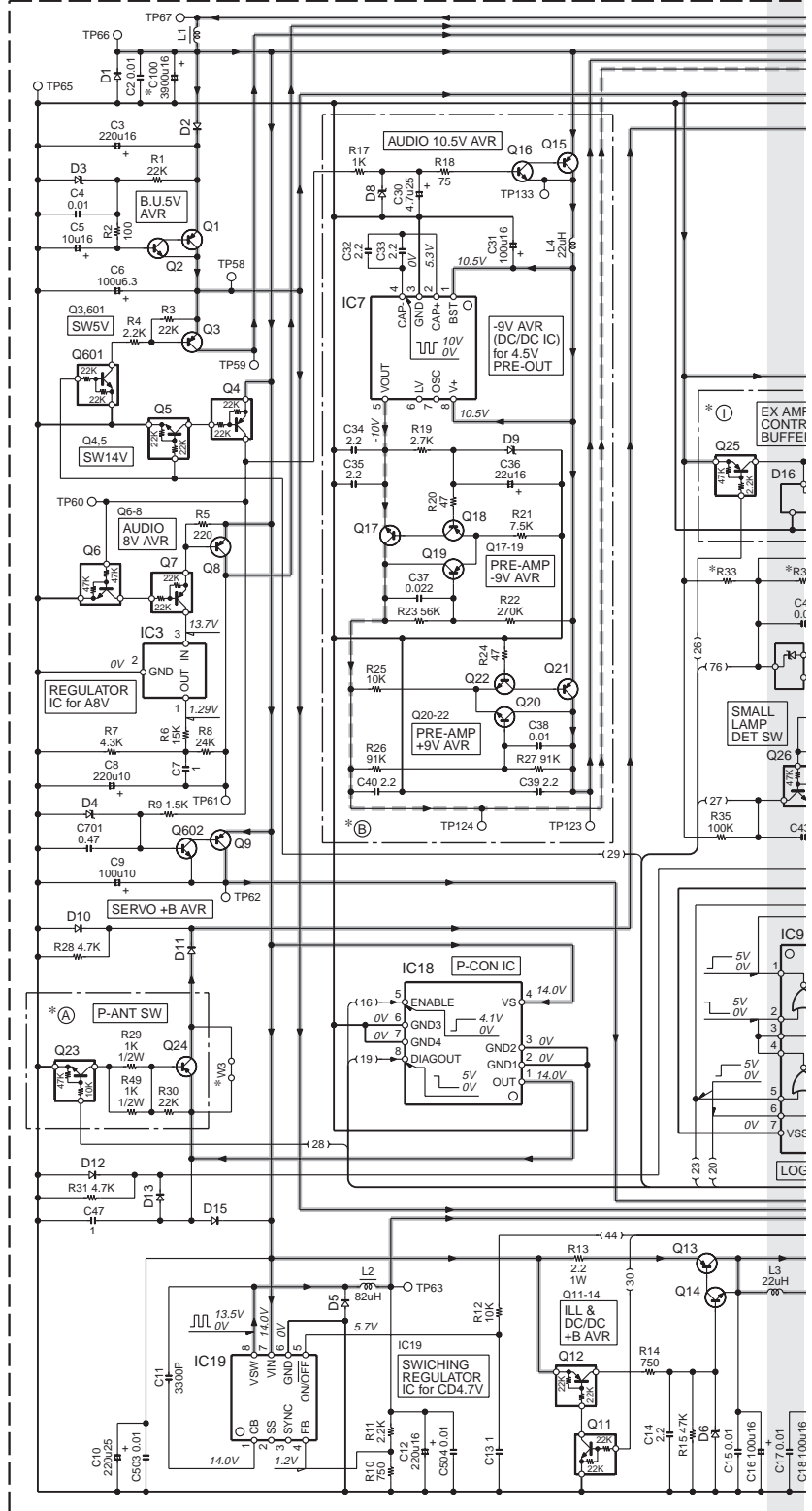

CAUTION : For continued safety, replace safety critical components only with manufacturer's recommended parts (refer to parts list).

⚠ Indicates safety critical components. To reduce the risk of electric shock, leakage-current or resistance measurements shall be carried out (exposed parts are acceptably insulated from the supply circuit) before the appliance is returned to the customer.

• DC voltages are as measured with a high impedance voltmeter. Values may vary slightly due to variations between individual instruments or/and units.

KDC-MP925/W8027

(X34-303x-xx)

MODEL NAME	UNIT No.	C264,265,268,269	C297,298	C501	C502	C505	R33	R34	R106	R107	R108	R109	R124-126	R146,149,154,155,521	R222,223,234,235,246,247	R230,231,242,243,254,255	W3
KDC-MP925	0-10	C94-0040	22u16	NO	YES	NO	47K	22K	YES	NO	NO	YES	NO	NO	2.2K	NO	NO
KDC-X879	0-11	C94-0040	22u16	NO	YES	NO	47K	22K	YES	YES	NO	NO	NO	NO	2.2K	NO	NO
FX-9100	0-01	C94-0039	10u16	NO	NO	NO	100K	47K	NO	YES	YES	NO	NO	YES	2.2K	YES	NO
KDC-W8027	2-71	C94-0039	10u16	YES	YES	NO	47K	22K	NO	NO	YES	YES	YES	NO	2.2K	YES	YES

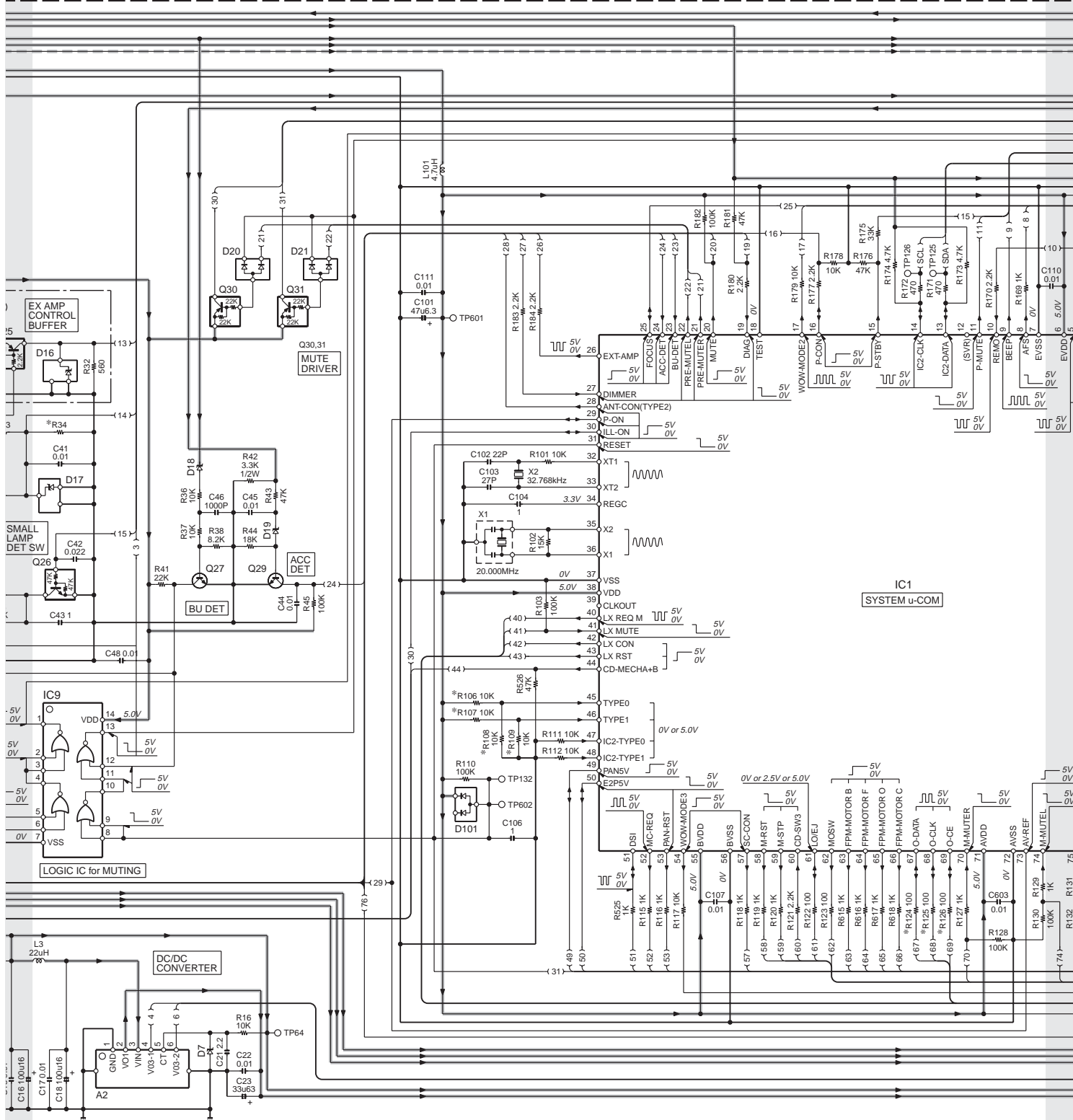

KDC-MP925/W8027

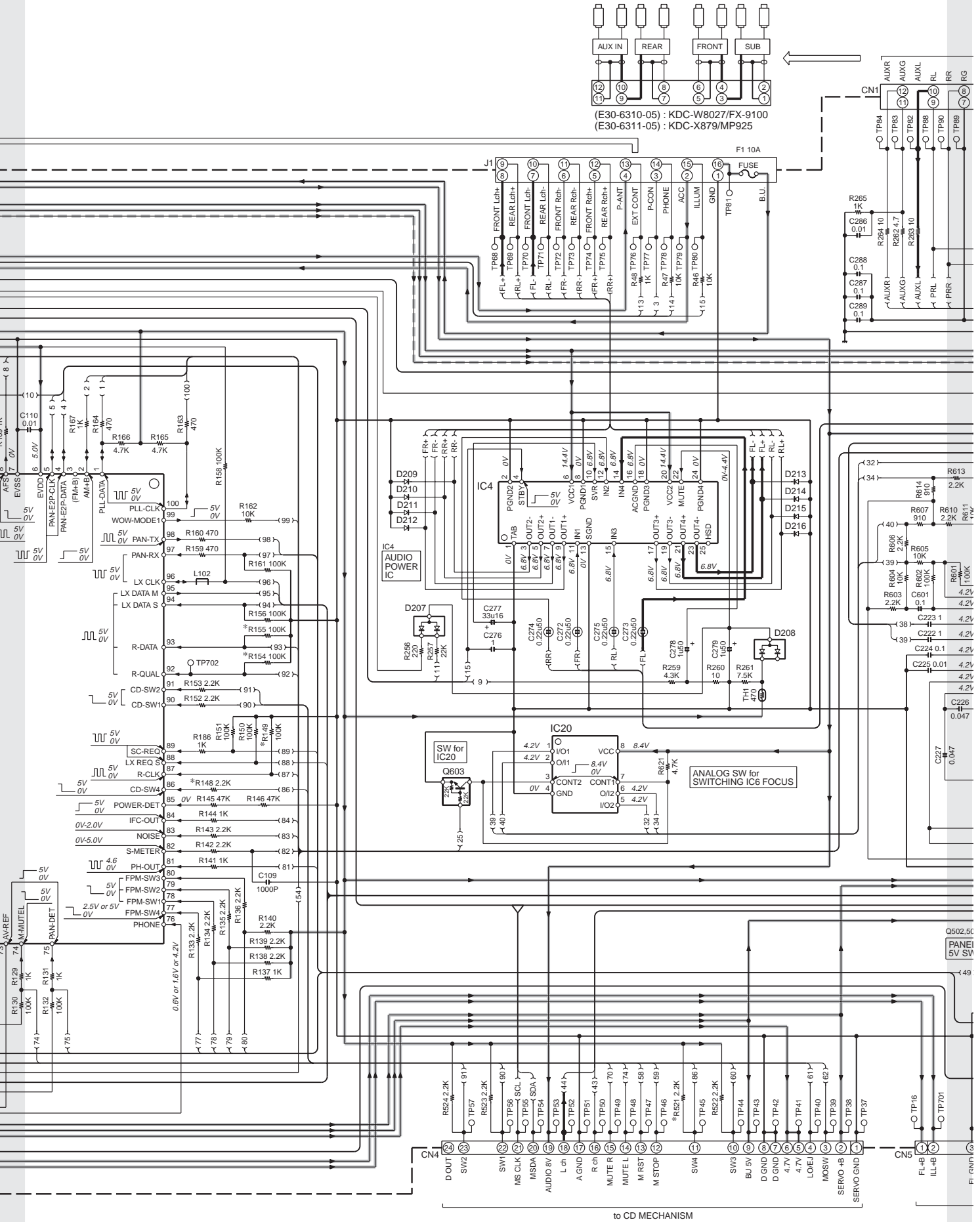

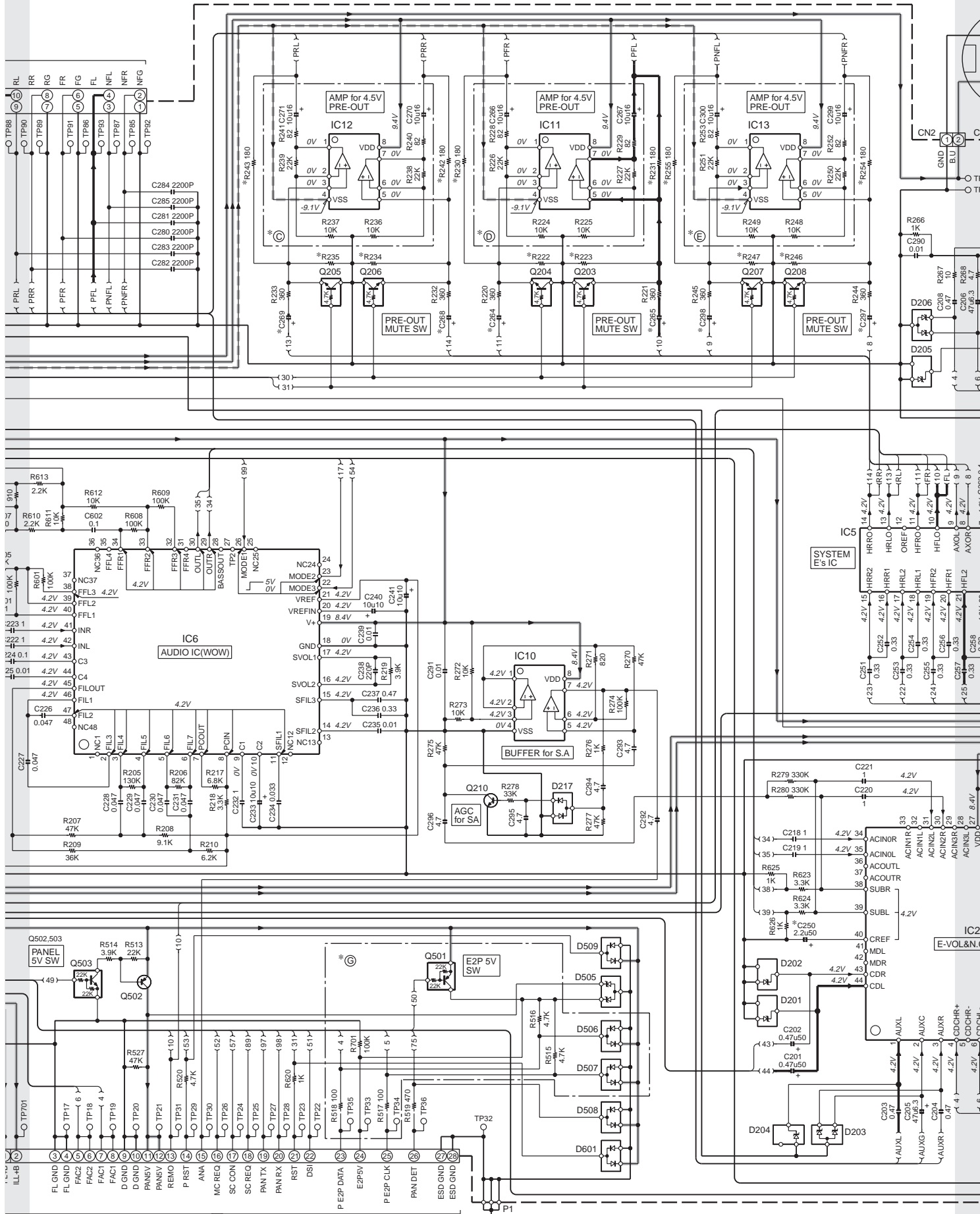

X16-253-CN1

KDC-MP925/W8027

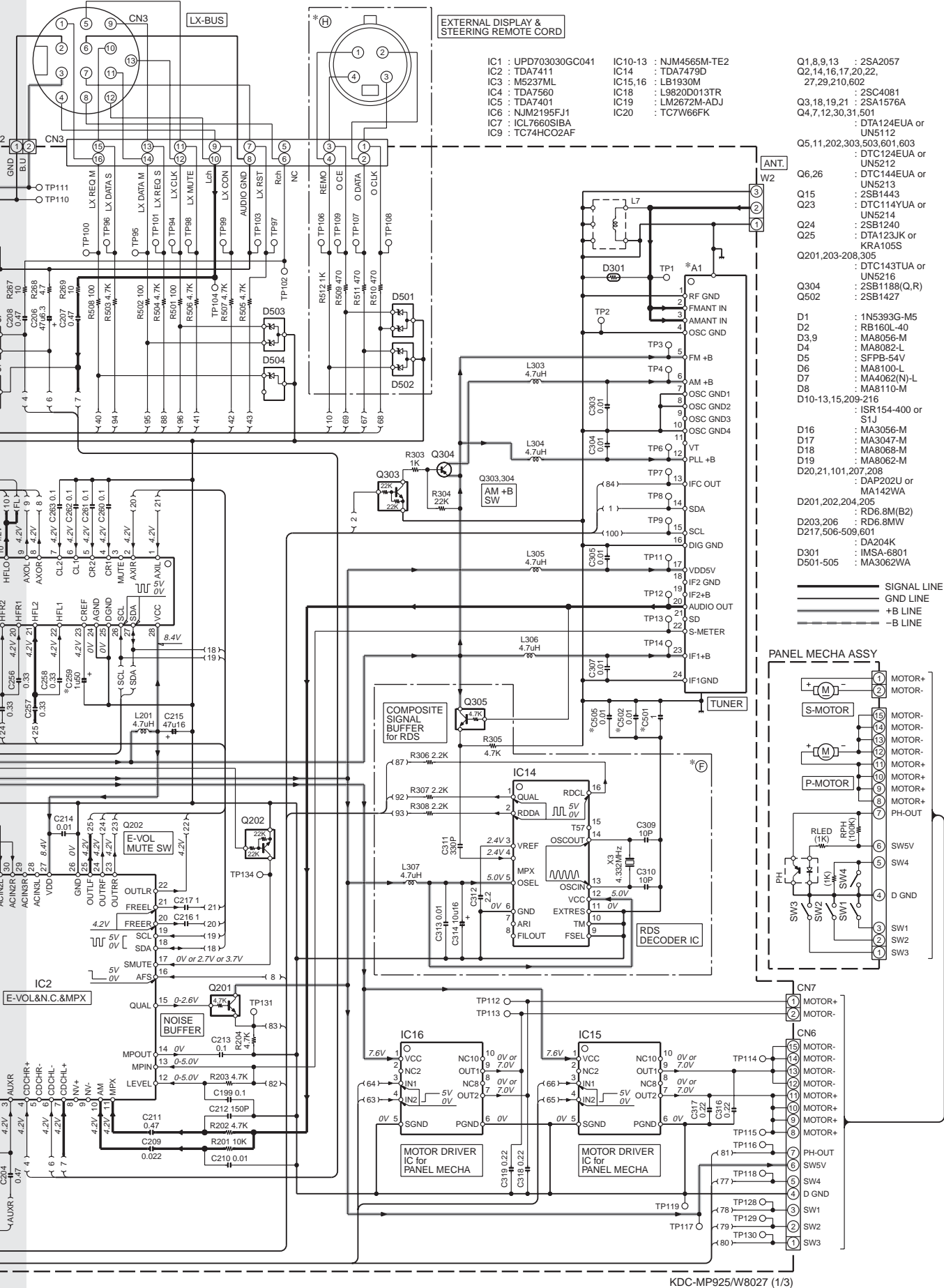

EXTERNAL DISPLAY & STEERING REMOTE CORD

- IC1 : UPD70303GC041
- IC2 : TDA7411
- IC3 : M5237ML
- IC4 : TDA7560
- IC5 : TDA7401
- IC6 : NJM2195FJ1
- IC7 : ICL7660SIBA
- IC9 : TC74HC02AF
- IC10-13 : NJM4565M-TE2
- IC14 : TDA7479D
- IC15,16 : LB1930M
- IC18 : L9820D013TR
- IC19 : LM2672M-ADJ
- IC20 : TC7W66FK

- Q1,8,9,13 : 2SA2057
- Q2,14,16,17,20,22,27,29,210,602
- Q3 : 2SC4081
- Q3,18,19,21 : 2SA1576A
- Q4,7,12,30,31,501 : DTA124EU or UN5112
- Q5,11,202,303,503,601,603 : DTC124EU or UN5212
- Q6,26 : DTC144EU or UN5213
- Q15 : 2SB1443
- Q23 : DTC114YUA or UN5214
- Q24 : 2SB1240
- Q25 : DTA123JK or KRA105S
- Q201,203-208,305 : DTC143TUA or UN5216
- Q304 : 2SB1188(Q,R)
- Q502 : 2SB1427
- D1 : 1N5393G-M5
- D2 : RB16L-40
- D3,9 : MA8056-M
- D4 : MA8082-L
- D5 : SFPB-54V
- D6 : MA8105-L
- D7 : MA4062(N)-L
- D8 : MA8110-M
- D10-13,15,209-216 : ISR154-400 or S1J
- D16 : MA3056-M
- D17 : MA3047-M
- D18 : MA8068-M
- D19 : MA8062-M
- D20,21,101,207,208 : DAP202U or MA142WA
- D201,202,204,205 : RD6.8M(B2)
- D203,206 : RD6.8MW
- D217,506-509,601 : DA204K
- D301 : IMSA-6801
- D501-505 : MA3062WA

— SIGNAL LINE
 — GND LINE
 — +B LINE
 — -B LINE

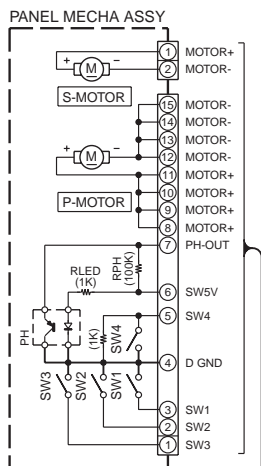

KDC-MP925/W8027 (1/3)

KDC-MP925/W8027

DISPLAY UNIT (X16-2530-1x)

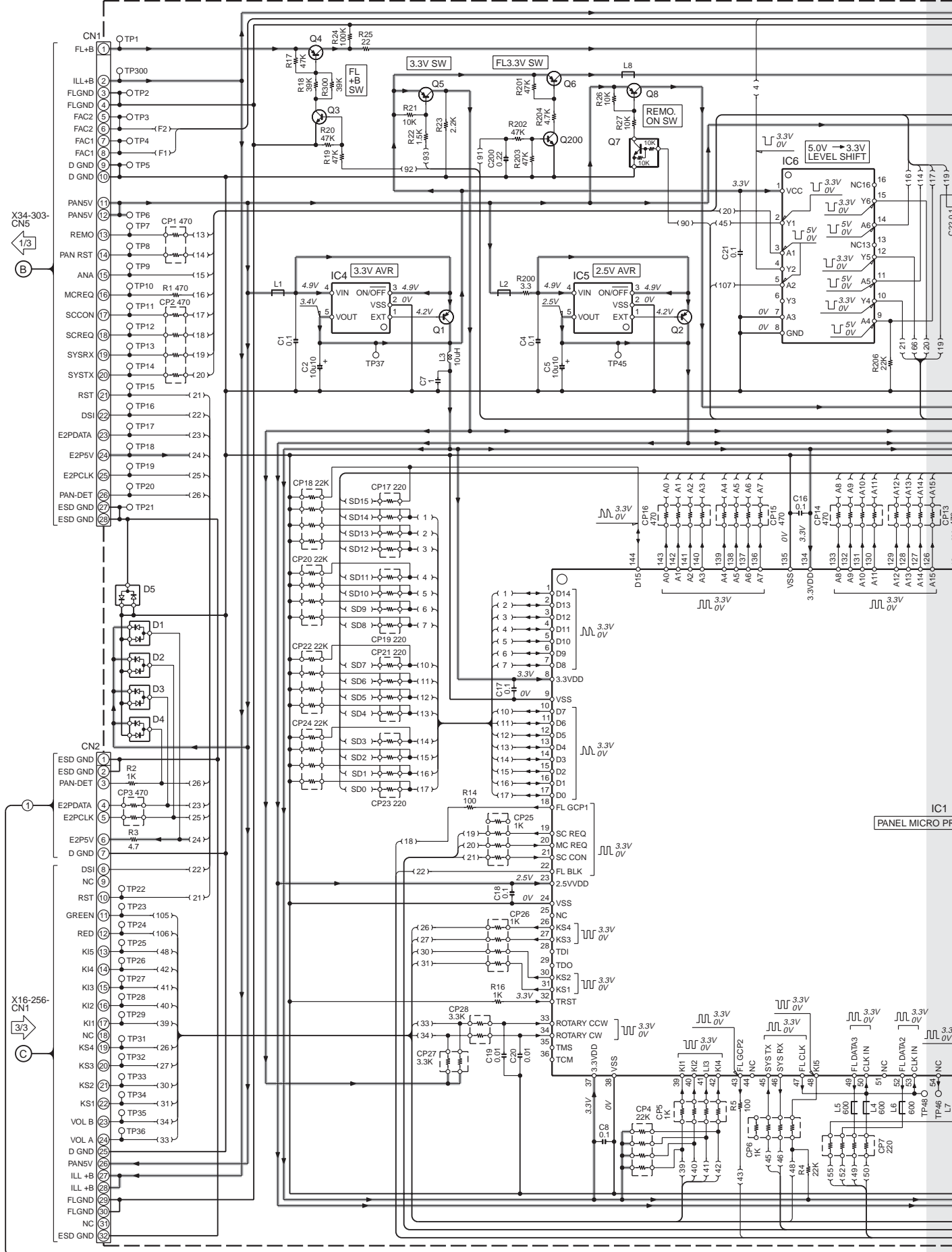

1

2

3

4

5

6

7

KDC-MP925/W8027

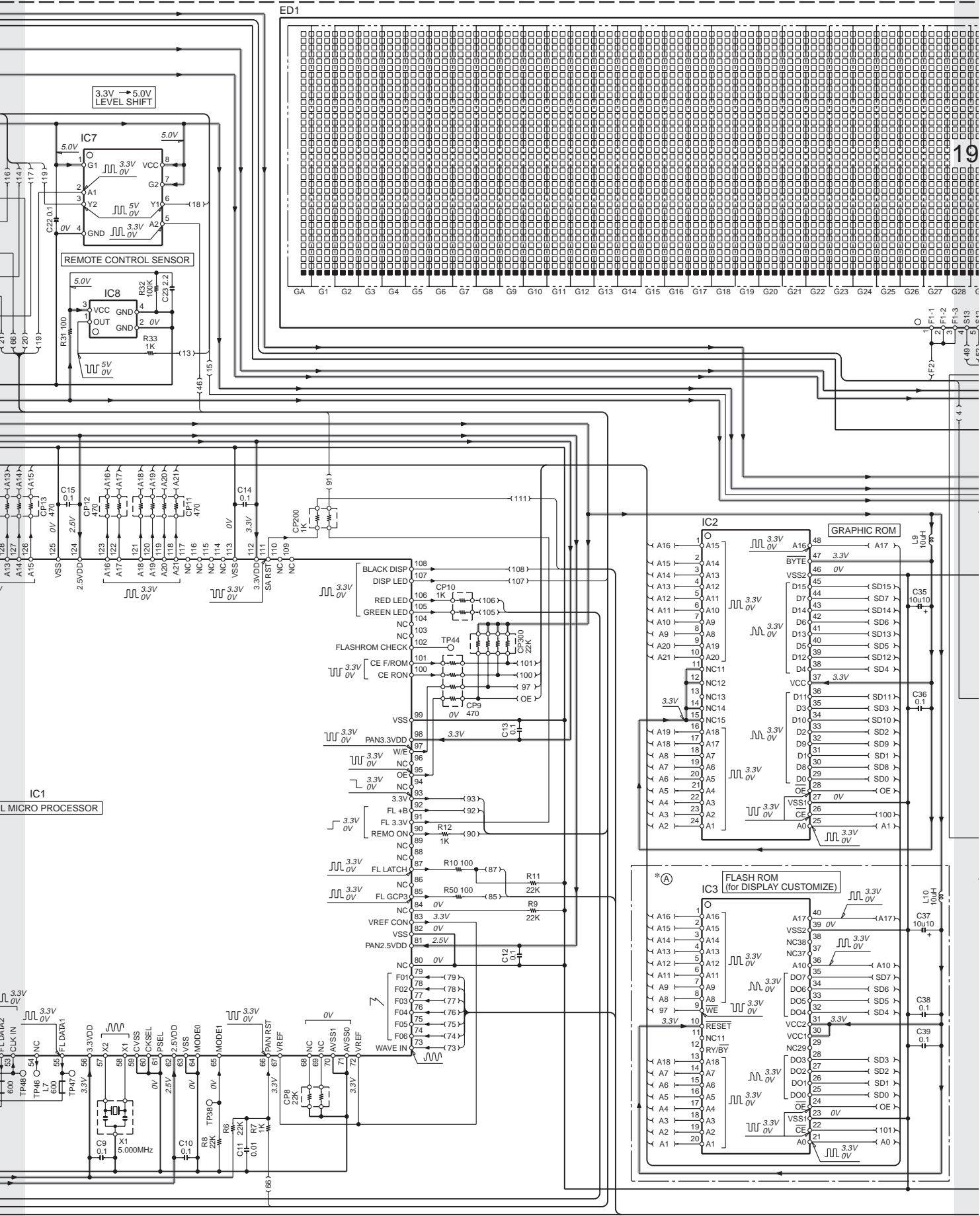

19

192x36 Dot Matrix

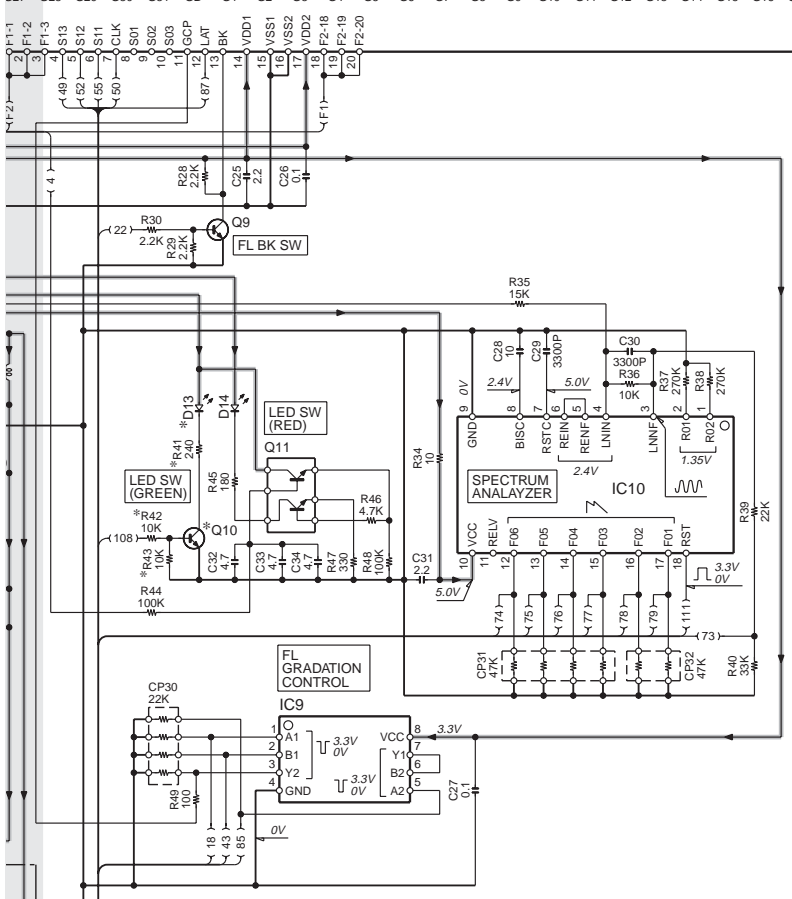
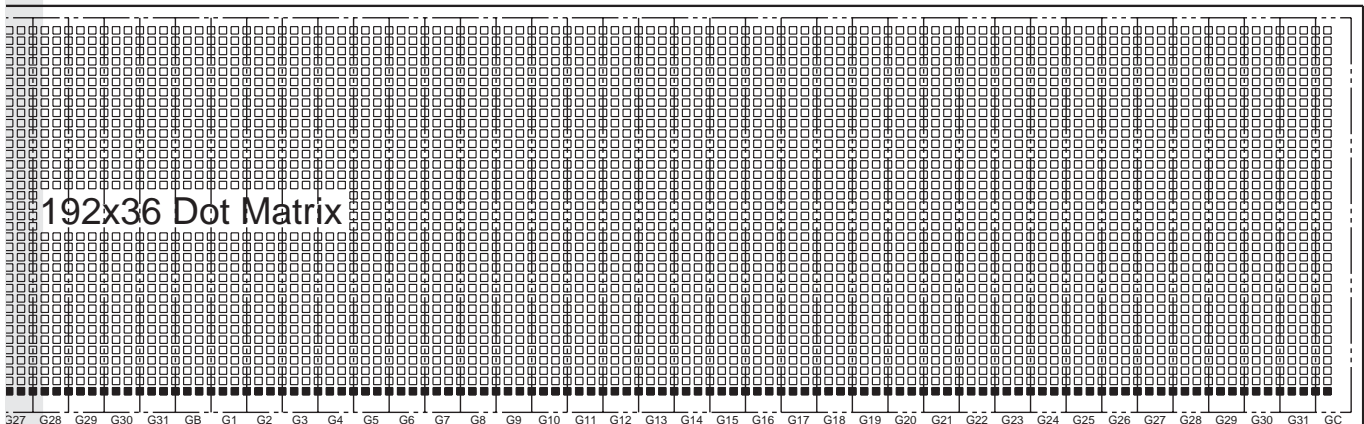

- IC1 : 703132GJ011-A
 - IC2 : MX23L3213TG114
 - IC3 : MBM29LV004T-90
 - IC4 : S-816A34AMCT2G
 - IC5 : S-816A25AMCT2G
 - IC6 : TC74HC0405AFT
 - IC7 : TC7WT126FU
 - IC8 : RS-171
 - IC9 : TC7WH32FU-F
 - IC10 : BA3830F
- (X16-2530-xx)
- | MODEL NAME | UNIT No. | (A) | D13 | Q10 | R41-43 |
|-------------|----------|-----|-----|-----|--------|
| KDC-X879 | 0-10 | YES | YES | YES | YES |
| KDC-PSW9527 | | | | | |
| FX-9100 | | | | | |
| KDC-X979 | | | | | |
| KDC-9026R | 0-11 | NO | NO | NO | NO |
| KDC-W9027 | | | | | |
- Q1 : 2SB1188(Q,R)
 - Q2 : 2SB1132
 - Q3 : 2SC2713
 - Q4 : 2SA1163
 - Q5,6,8 : 2SA1774
 - Q7 : DTC114EE
 - Q9 : 2SC4667
 - Q10,200 : 2SC4617
 - Q11 : UMX2N
- D1-5 : DA204U
 D13 : B30-1575-05
 D14 : B30-2233-05
- GND LINE
 — +B LINE

- DTA123JK
- DTC114EE
- DTC114YUA
- DTC143TUA
- UN5114
- UN5213
- UN5214
- UN5216
- 2SA1163
- 2SA1576A
- 2SC2713
- 2SC4617
- 2SD2114K

- 2SA1774
- 2SC4081

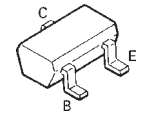

UMX2N

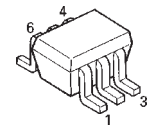

- 2SB1132
- 2SB1188

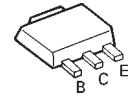

- DTA124EUA
- DTC124EUA
- DTC144EUA

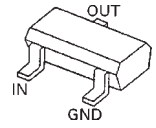

- 2SB1443

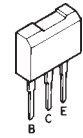

NJM4565M-TE2

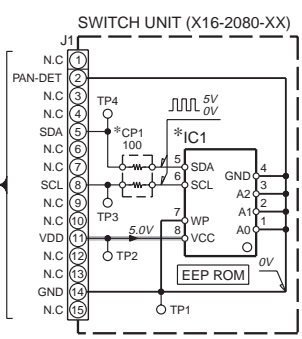
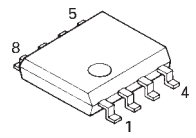

IC1 : BR24C01AFV-W
(X16-2080-xx)

MODEL NAME	UNIT No.	CP1	IC1
KDC-X969			
KDC-9023R	0-10	YES	YES
KDC-PSW9524			
FX-9000	0-01	NO	NO

CAUTION : For continued safety, replace safety critical components only with manufacturer's recommended parts (refer to parts list). **Δ** Indicates safety critical components. To reduce the risk of electric shock, leakage-current or resistance measurements shall be carried out (exposed parts are acceptably insulated from the supply circuit) before the appliance is returned to the customer.

- DC voltages are as measured with a high impedance voltmeter. Values may vary slightly due to variations between individual instruments or/and units.

KDC-MP925/W8027

SWITCH UNIT (X16-2560-xx)

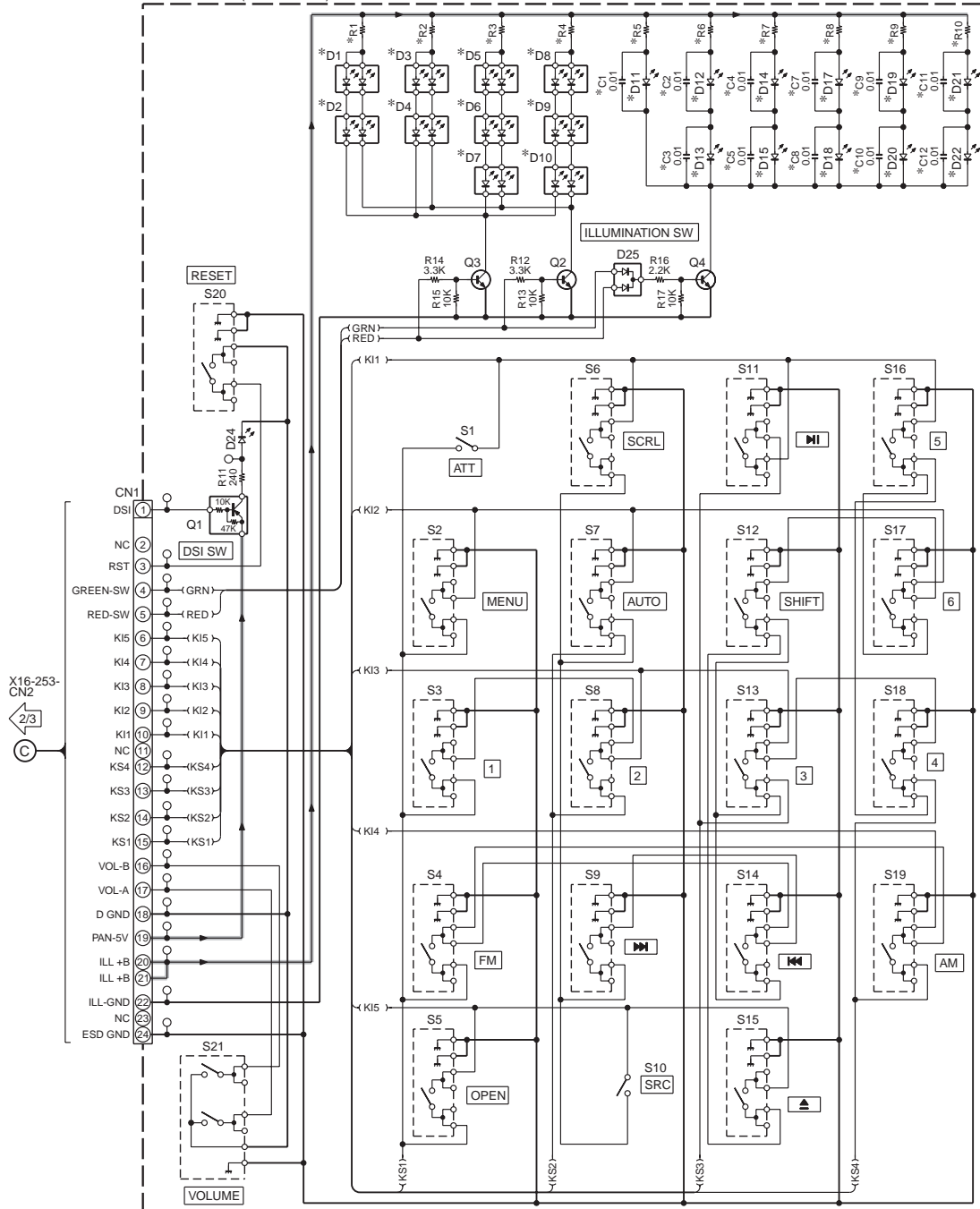

(X16-256x-xx)

MODEL NAME	UNIT No.	C1-5, 7-12	D1-10	D11-15, 17-22	R1.2	R3,4	R5	R6-10
KDC-X979/X879								
KDC-9026R								
KDC-PSW9527	0-10	YES	SR/PG	BLUE	470	300	470	180
KDC-W9027								
KDC-W8027								
KDC-MP925								
KDC-MPV8025								
KDC-MP825	0-11	NO	SR/PG	RED	560	390	750	560
KDC-8026								
KDC-W7027								
KDC-7027Y								
FX-9100	0-01	YES	HR/YG	BLUE	470	330	470	180

Q1 : DTA114YUA

Q2-4 : 2SD2114K

D24 : B30-1566-05

D25 : DAN222

— GND LINE
 — +B LINE

KDC-MP925/W8027 (3/3)

DAN202U



DAP202U

DA204K

DA204U

DTA114YUA



MA142WA

UN5212



RD6.8M



TC74HC02AF

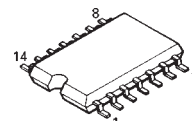

BA3830F

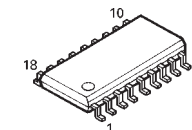

TC7SH08FU

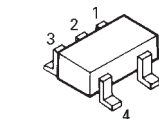

M5237ML

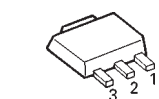

LB1930M

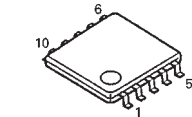

TC74HC4050AFT

TDA7479D

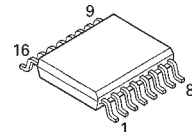

CAUTION : For continued safety, replace safety critical components only with manufacturer's recommended parts (refer to parts list).

△ Indicates safety critical components. To reduce the risk of electric shock, leakage-current or resistance measurements shall be carried out (exposed parts are acceptably insulated from the supply circuit) before the appliance is returned to the customer.

- DC voltages are as measured with a high impedance voltmeter. Values may vary slightly due to variations between individual instruments or/and units.

KDC-MP925/W8027

CD PLAYER UNIT (X32-5500-00/01,5540-00/01)

1
2
3
4
5
6
7

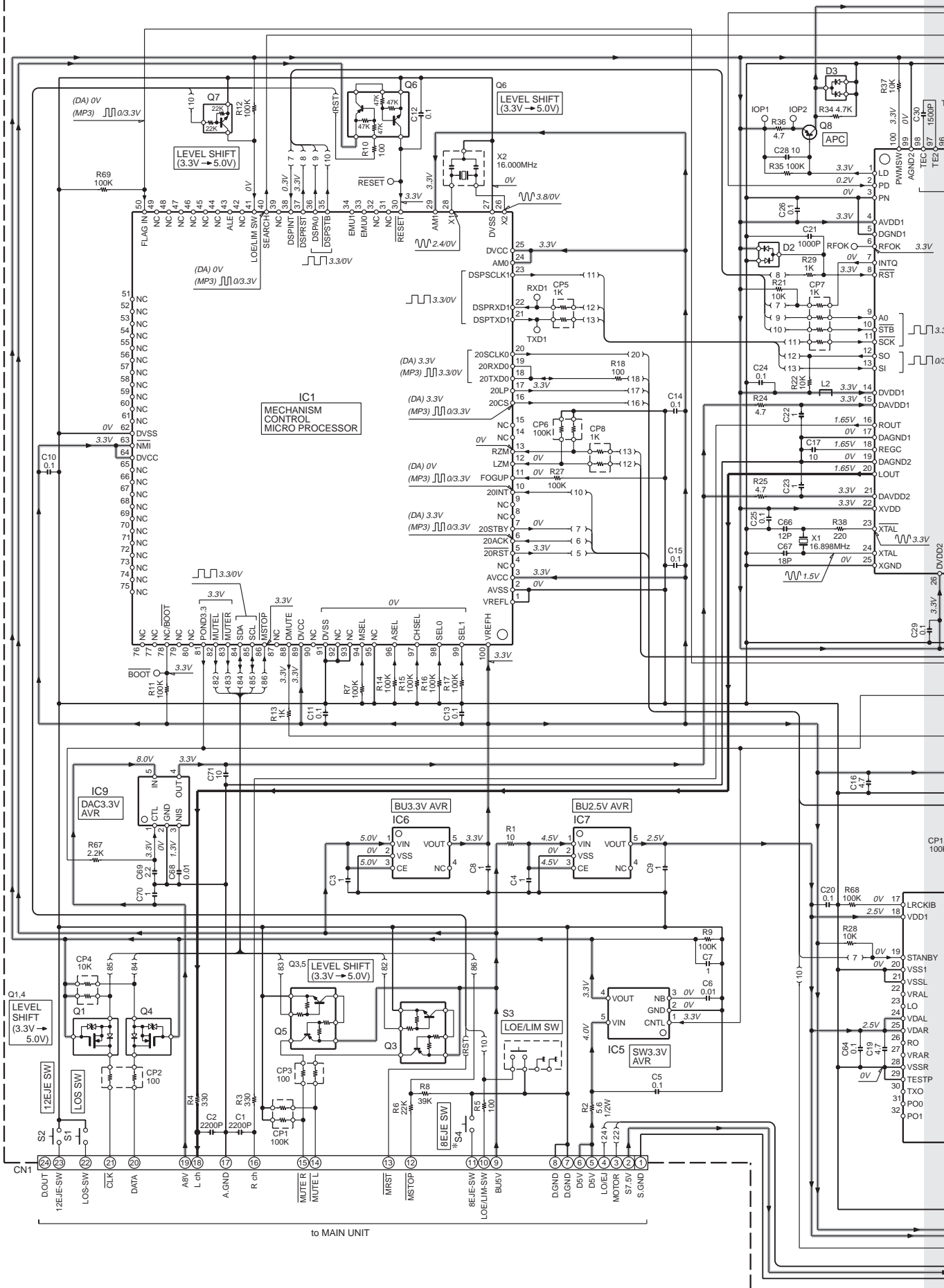

to MAIN UNIT

KDC-MP925/W8027

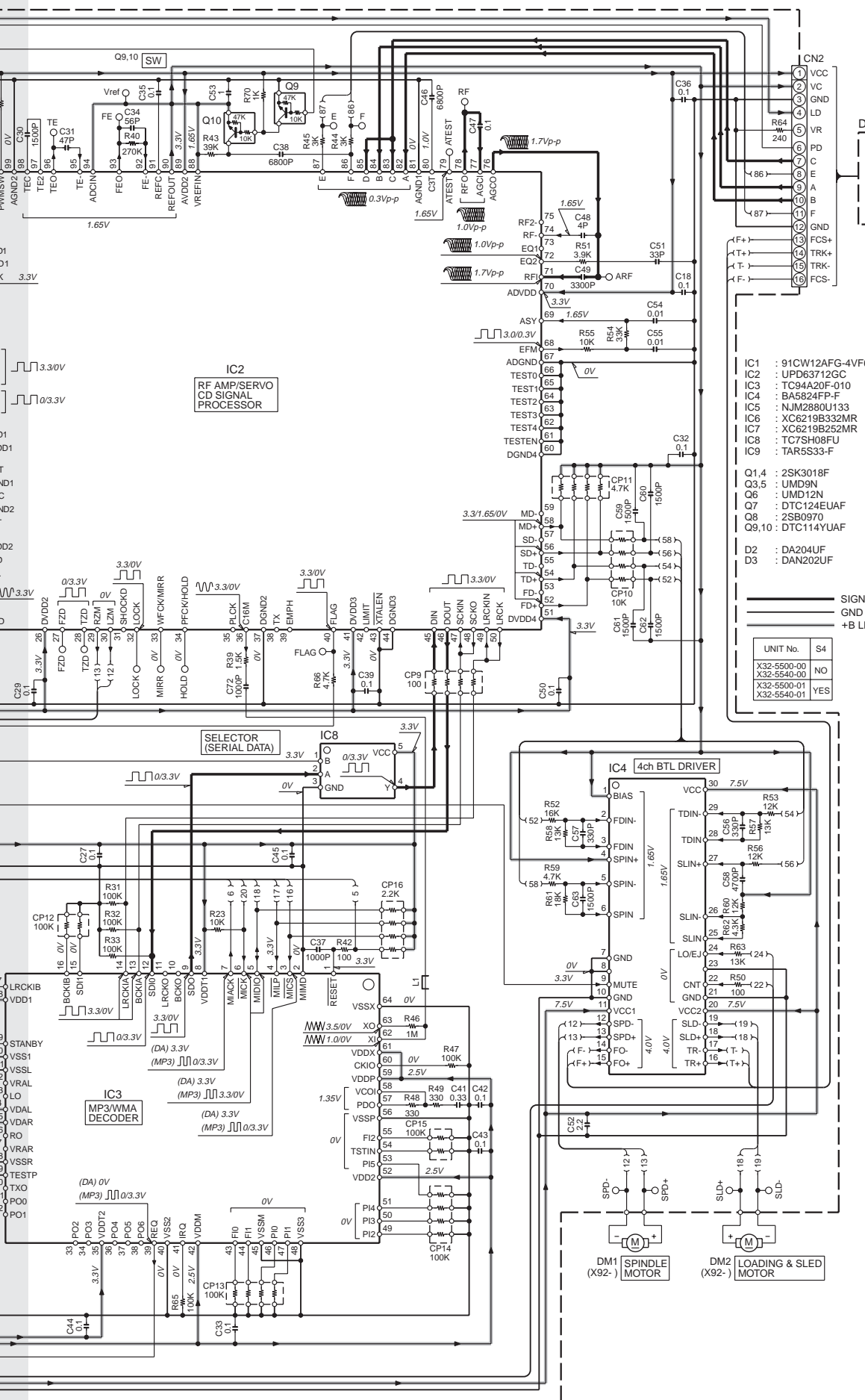

- IC1 : 91CW12AFG-4V6
 - IC2 : UPD63712GC
 - IC3 : TC9420F-010
 - IC4 : BA5824FP-F
 - IC5 : NJM2880U133
 - IC6 : XC6219B332MR
 - IC7 : XC6219B252MR
 - IC8 : TC7SH08FU
 - IC9 : TAR5S33-F
- Q1,4 : 2SK3018F
 - Q3,5 : UMD9N
 - Q6 : UMD12N
 - Q7 : DTC124EUAF
 - Q8 : 2SB0970
 - Q9,10 : DTC114YUAF
- D2 : DA204UF
 - D3 : DAN202UF

UNIT No.	S4
X32-5500-00	NO
X32-5540-00	NO
X32-5500-01	YES
X32-5540-01	YES

CAUTION : For continued safety, replace safety critical components only with manufacturer's recommended parts (refer to parts list).

⚠ Indicates safety critical components. To reduce the risk of electric shock, leakage-current or resistance measurements shall be carried out (exposed parts are acceptably insulated from the supply circuit) before the appliance is returned to the customer.

- DC voltages are as measured with a high impedance voltmeter. Values may vary slightly due to variations between individual instruments or/and units.

EXPLODED VIEW (MECHANISM)

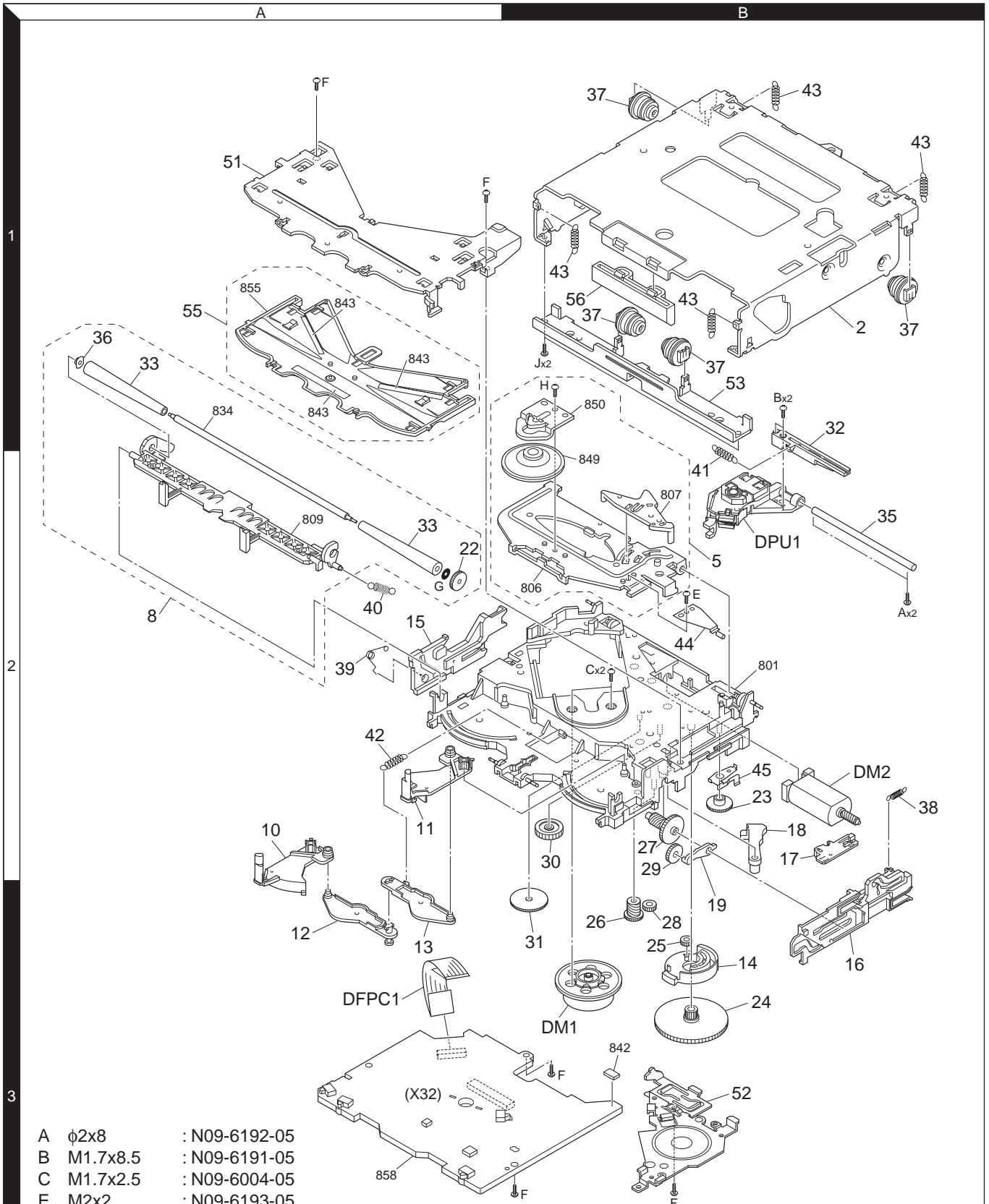

A	φ2x8	: N09-6192-05
B	M1.7x8.5	: N09-6191-05
C	M1.7x2.5	: N09-6004-05
E	M2x2	: N09-6193-05
F	φ2x6(BLK)	: N09-6194-05
G	1.6 WASHER	: N19-2163-04
H	M2x2	: N39-2020-46
J	φ2x3.5	: N09-6196-05

* CD MECHANISM OPERATION DESCRIPTION is not in this service manual.
Please refer to service manual for X92-4450-0x (B51-7889-00).

KDC-MP925/W8027

EXPLODED VIEW (UNIT)

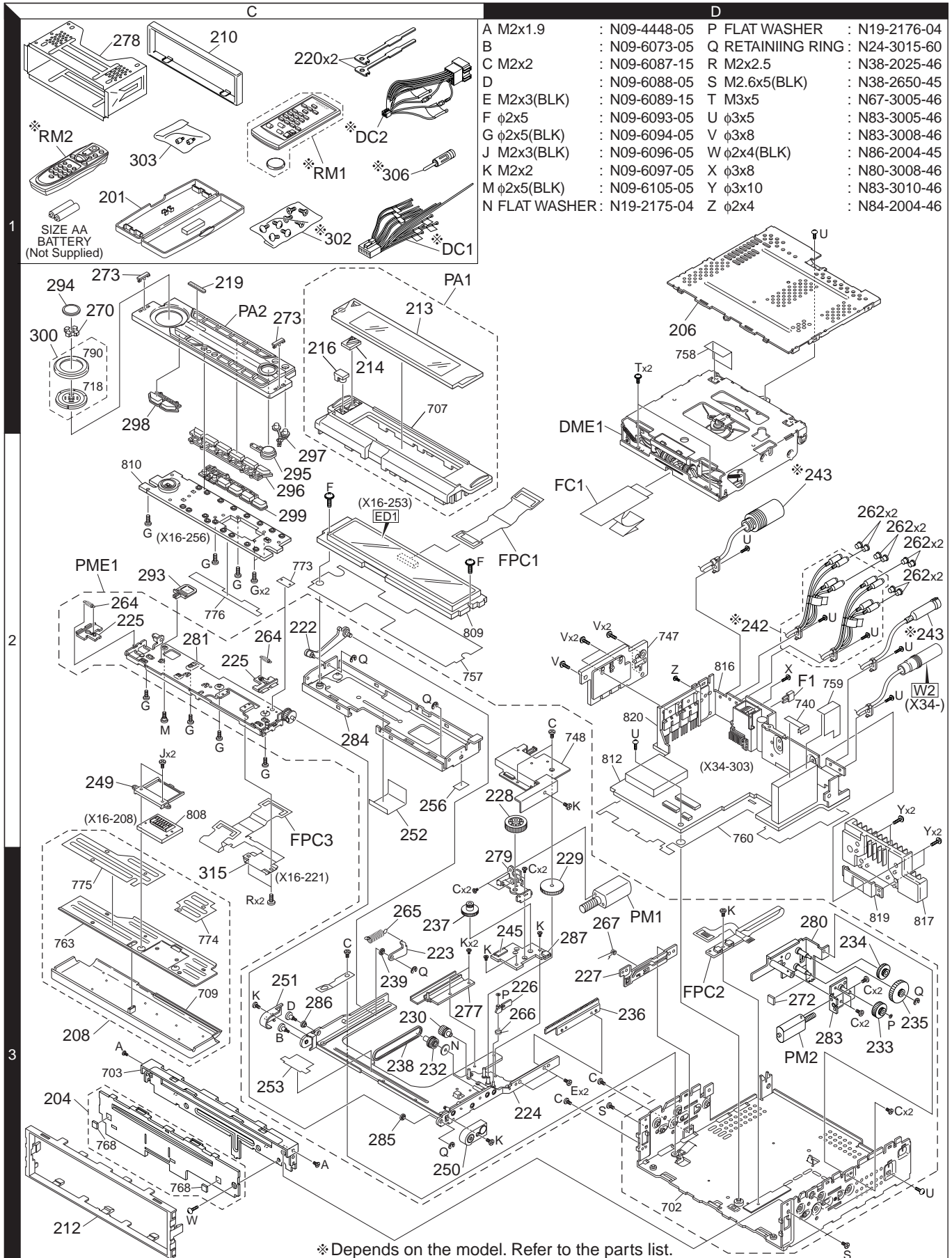

PARTS LIST

* New parts

Parts without **Parts No.** are not supplied.

Les articles non mentionnés dans le **Parts No.** ne sont pas fournis.

Teile ohne **Parts No.** werden nicht geliefert.

Ref. No.	A d d	N e w	Parts No.	Description	Desti- nation
KDC-MP925/KDC-W8027					
201	1C		A02-2731-13	PLASTIC CABINET ASSY	
204	3C		A22-2988-03	SUB PANEL ASSY	
206	1D		A52-0831-02	TOP PLATE	
PA1	1D	*	A64-3226-01	PANEL ASSY	K1
PA1	1D	*	A64-3232-01	PANEL ASSY	E1
PA2	1C	*	A64-3248-02	PANEL ASSY	K1
PA2	1C	*	A64-3252-02	PANEL ASSY	E1
PME1	2C	*	A10-5123-01	CHASSIS ASSY	△
RM1	1C		A70-2026-05	REMOTE CONTROLLER ASSY (RC-420)	E1
RM2	1C		A70-2040-05	REMOTE CONTROLLER ASSY (RC-505)	K1
-			B46-0100-50	WARRANTY CARD	
-			B46-0606-04	ID CARD	K1
-			B46-0612-14	ID CARD	E1
-		*	B64-2741-00	INST. MANUAL (ENGLISH)	K1
-		*	B64-2742-00	INST. MANUAL (FRE, SPA)	K1
-		*	B64-2746-00	INST. MANUAL (ENGLISH)	E1
-		*	B64-2747-00	INST. MANUAL (FRE, GER)	E1
-		*	B64-2748-00	INST. MANUAL (DUT, ITA)	E1
-		*	B64-2749-00	INST. MANUAL (SPA, POR)	E1
208	3C		B03-5015-03	DRESSING PLATE ASSY	
210	1C		B07-3078-01	ESCUTCHEON	
212	3C		B07-3080-02	ESCUTCHEON	
213	1D	*	B10-4513-01	FRONT GLASS	K1
213	1D	*	B10-4519-01	FRONT GLASS	E1
214	1C	*	B12-1227-04	INDICATOR	
216	1C	*	B19-2248-04	LIGHTING BOARD	
219	1C		B43-1505-04	KENWOOD BADGE	
220	1C		D10-4674-04	LEVER	
222	2C		D10-4716-04	ARM ASSY	
223	3C		D10-4718-04	ARM ASSY	
224	3D		D10-4721-21	SLIDER ASSY	
225	2C		D10-4749-03	LEVER	
226	3D		D10-4750-04	LEVER	
227	3D		D12-0637-03	CAM	
228	2D		D13-2270-04	GEAR	
229	3D		D13-2272-04	GEAR	
230	3C		D13-2273-34	GEAR	
232	3C		D13-2274-24	GEAR	
233	3D		D13-2276-04	GEAR	
234	3D		D13-2277-04	GEAR	
235	3D		D13-2278-04	GEAR	
236	3D		D13-2289-03	RACK (GEAR)	
237	3C		D13-2290-04	GEAR ASSY	
238	3C		D16-0617-15	BELT	
239	3C		D23-0958-04	RETAINER	
242	2D	*	E30-6310-05	CORD WITH PINPLUG (2PR+1AUX)	E1
242	2D	*	E30-6311-05	CORD WITH PINPLUG (3PR+1AUX)	K1
243	2D		E30-6216-05	CORD WITH DIN CONNECTOR (CH)	K1
243	2D		E30-6217-05	CORD WITH DIN CONNECTOR (&REM)	E1
245	3D		E41-0351-05	FLAT CABLE CONNECTOR	
△ DC1	1C		E30-6295-05	DC CORD	K1
△ DC2	1C		E30-4942-05	DC CORD	E1

Ref. No.	A d d	N e w	Parts No.	Description	Desti- nation
FC1	2D		E39-0565-05	FLAT CABLE	
249	2C		F07-1121-03	COVER	
250	3C		F07-1122-03	COVER	
251	3C		F07-1123-03	COVER	
252	2C		F09-1794-04	SHEET	
253	3C		F09-1798-04	SHEET	
256	2D		F09-1842-04	SHEET	
262	2D		F29-0626-04	INSULATING COVER	
F1	2D		F52-0023-05	FUSE (MINI BLADE TYPE : 10A)	
264	2C	*	G01-3162-04	EXTENSION SPRING	
265	2C		G01-3221-04	EXTENSION SPRING	
266	3C		G01-3189-04	TORSION COIL SPRING	
267	3D		G01-3199-04	TORSION COIL SPRING	
270	2C		G11-3539-04	CUSHION	
272	3D		G11-3559-04	CUSHION	
273	1C		G11-3574-04	CUSHION (KEY)	K1
273	1C		G11-3575-04	CUSHION (KEY)	E1
-		*	H10-4854-22	POLYSTYRENE FOAMED FIXTURE	
-			H21-1151-04	PROTECTION SHEET	
-			H25-0329-04	PROTECTION BAG (280X450X0.03)	K1
-			H25-0337-04	PROTECTION BAG (180X300X0.03)	
-			H25-1111-04	PROTECTION BAG (280X450X0.03)	E1
-		*	H54-3029-03	ITEM CARTON CASE	K1
-		*	H54-3035-03	ITEM CARTON CASE	E1
277	3C		J19-5220-03	HOLDER	
278	1C		J21-9823-03	MOUNTING HARDWARE ASSY	
279	3D		J21-9951-03	MOUNTING HARDWARE ASSY	
280	3D		J21-9954-02	MOUNTING HARDWARE ASSY	
281	2C	*	J21-9996-32	MOUNTING HARDWARE ASSY	
283	3D		J21-9997-03	MOUNTING HARDWARE ASSY	
284	2C		J21-9999-02	MOUNTING HARDWARE ASSY	
285	3C		J31-1055-04	COLLAR	
286	3C		J31-1056-04	COLLAR	
287	3D		J74-1444-14	RIGID PRINTED WIRING BOARD	
FPC1	2D		J84-0153-05	FLEXIBLE PRINTED WIRING BOARD	
FPC2	3D		J84-0156-04	FLEXIBLE PRINTED WIRING BOARD	
293	2C		K24-4007-04	KNOB (OPEN)	
294	1C	*	K24-4106-03	KNOB (ATT)	
295	1C	*	K24-4167-03	KNOB (SRC)	
296	1C	*	K25-1605-02	KNOB (PRESET1-6)	K1
296	1C	*	K25-1632-02	KNOB (PRESET1-6)	E1
297	2C	*	K25-1607-03	KNOB (EJECT)	K1
297	2C	*	K25-1634-03	KNOB (EJECT)	E1
298	1C	*	K25-1609-03	KNOB (Q, PLAY)	K1
298	1C	*	K25-1610-03	KNOB (Q, PLAY)	E1
299	2C	*	K25-1612-02	KNOB (FM/AM, SKIP)	K1
299	2C	*	K25-1633-02	KNOB (FM/AM, SKIP)	E1
300	1C	*	K29-7082-03	KNOB ASSY (VOL.)	
302	1C		N99-1723-05	SCREW SET	K1
303	1C		N99-1734-05	SCREW SET	
A	3D		N09-4448-05	MACHINE SCREW	
B	3C		N09-6073-05	STEPPED SCREW	

K1 : KDC-MP925 E1 : KDC-W8027

△ Indicates safety critical components.

PARTS LIST

* New parts

Parts without **Parts No.** are not supplied.

Les articles non mentionnés dans le **Parts No.** ne sont pas fournis.

Teile ohne **Parts No.** werden nicht geliefert.

KDC-MP925/KDC-W8027

Ref. No.	Ad	New	Parts No.	Description	Desti-nation
C	3D	*	N09-6087-15	MACHINE SCREW	
D	3C		N09-6088-05	STEPPED SCREW	
E	3D	*	N09-6089-15	MACHINE SCREW	
F	2C		N09-6093-05	TAPTITE SCREW	
G	2C		N09-6094-05	MACHINE SCREW	
J	2C		N09-6096-05	MACHINE SCREW	
K	3C		N09-6097-05	MACHINE SCREW	
M	2C		N09-6105-05	STEPPED SCREW	
N	2C		N19-2175-04	FLAT WASHER	
P	3D		N19-2176-04	FLAT WASHER	
Q	2C		N24-3015-60	E TYPE RETAINING RING	
R	3C		N38-2025-46	PAN HEAD MACHIN SCREW	
S	3D		N38-2650-45	PAN HEAD MACHIN SCREW	
T	2D		N67-3005-46	PAN HEAD SEMS SCREW	
U	2D		N83-3005-46	PAN HEAD TAPTITE SCREW	
V	2D		N83-3008-46	PAN HEAD TAPTITE SCREW	
W	3C		N86-2004-45	BINDING HEAD TAPTITE SCREW	
RLED			RK73GB2A102J	CHIP R 1.0K J 1/10W	
RPH			RK73GB2A104J	CHIP R 100K J 1/10W	
SW1			S68-0871-05	PUSH SWITCH (PANEL MECHA)	
SW2-3			S68-0863-05	PUSH SWITCH (PANEL MECHA)	
SW4			S68-0864-05	PUSH SWITCH (PANEL MECHA)	
306	1C		T90-0552-05	ANTENNA ADAPTOR	E1
PH			T95-0212-05	OPTO ISOLATOR (PANEL MECHA)	
PM1	3D		T42-1076-14	MOTOR ASSY	
PM2	3D	*	T42-1077-24	MOTOR ASSY	
DME1	2D	*	X92-4900-00	MECHANISM ASSY (DXM-6540V)	
SUB CIRCUIT UNIT (X16-2080-10)					
J1			E59-0833-15	RECTANGULAR PLUG	
CP1			R90-1019-05	MULTI-COMP 100 X2	
IC1			BR24C01AFV-W	MEMORY IC	
SUB CIRCUIT UNIT (X16-2210-10)					
315	3C		E58-0968-05	RECTANGULAR RECEPTACLE	
FPC3	2C		J84-0154-05	FLEXIBLE PRINTED WIRING BOARD	
DISPLAY UNIT (X16-2530-11)					
D14			B30-2233-05	LED (HR 1608)	
C1			CK73GB1C104K	CHIP C 0.10UF K	
C1			CK73GB1H104K	CHIP C 0.10UF K	
C2			C92-0628-05	CHIP-TAN 10UF 10WV	
C4			CK73GB1C104K	CHIP C 0.10UF K	
C4			CK73GB1H104K	CHIP C 0.10UF K	
C5			C92-0628-05	CHIP-TAN 10UF 10WV	
C7			CK73GB0J105K	CHIP C 1.0UF K	
C8-10			CK73GB1C104K	CHIP C 0.10UF K	
C8-10			CK73GB1H104K	CHIP C 0.10UF K	
C11			CK73GB1H103K	CHIP C 0.010UF K	
C12-18			CK73GB1C104K	CHIP C 0.10UF K	
C12-18			CK73GB1H104K	CHIP C 0.10UF K	
C19,20			CK73GB1H103K	CHIP C 0.010UF K	

Ref. No.	Ad	New	Parts No.	Description	Desti-nation
C21,22			CK73GB1C104K	CHIP C 0.10UF K	
C21,22			CK73GB1H104K	CHIP C 0.10UF K	
C23			CK73FB1A225K	CHIP C 2.2UF K	
C25			CK73FB1A225K	CHIP C 2.2UF K	
C26			C93-1174-05	CERAMIC 0.1UF 100WV	
C27			CK73GB1C104K	CHIP C 0.10UF K	
C27			CK73GB1H104K	CHIP C 0.10UF K	
C28			CK73EB0J106K	CHIP C 10UF K	
C29,30			CK73GB1H332K	CHIP C 3300PF K	
C31			CK73FB1A225K	CHIP C 2.2UF K	
C32-34			CK73FB0J475K	CHIP C 4.7UF K	
C35			C92-0628-05	CHIP-TAN 10UF 10WV	
C36			CK73GB1C104K	CHIP C 0.10UF K	
C36			CK73GB1H104K	CHIP C 0.10UF K	
C200			CK73GB1A224K	CHIP C 0.22UF K	
CN1			E40-9364-05	FLAT CABLE CONNECTOR (28PIN)	
CN2			E41-0166-05	FLAT CABLE CONNECTOR (32PIN)	
L1,2			L92-0321-05	CHIP FERRITE	
L3			L40-1005-34	SMALL FIXED INDUCTOR	
L3			L40-1005-68	SMALL FIXED INDUCTOR	
L4-8			L92-0332-05	CHIP FERRITE	
L9			L40-1005-34	SMALL FIXED INDUCTOR	
L9			L40-1005-68	SMALL FIXED INDUCTOR	
X1			L78-0868-05	RESONATOR (5.00MHZ)	
CP1			R90-1022-05	MULTI-COMP 470 X2	
CP2			RK74HB1J471J	CHIP-COM 470 J 1/16W	
CP3			R90-1022-05	MULTI-COMP 470 X2	
CP4		*	RK74HB1J223J	CHIP-COM 22K J 1/16W	
CP5,6			RK74HB1J102J	CHIP-COM 1.0K J 1/16W	
CP7			RK74HB1J221J	CHIP-COM 220 J 1/16W	
CP8			R90-1020-05	MULTI-COMP 22K X2	
CP9			RK74HB1J471J	CHIP-COM 470 J 1/16W	
CP10			RK74GA1J102J	CHIP-COM 1.0K J 1/16W	
CP11			RK74HB1J471J	CHIP-COM 470 J 1/16W	
CP12			R90-1022-05	MULTI-COMP 470 X2	
CP13-16			RK74HB1J471J	CHIP-COM 470 J 1/16W	
CP17			RK74HB1J221J	CHIP-COM 220 J 1/16W	
CP18		*	RK74HB1J223J	CHIP-COM 22K J 1/16W	
CP19			RK74HB1J221J	CHIP-COM 220 J 1/16W	
CP20		*	RK74HB1J223J	CHIP-COM 22K J 1/16W	
CP21			RK74HB1J221J	CHIP-COM 220 J 1/16W	
CP22		*	RK74HB1J223J	CHIP-COM 22K J 1/16W	
CP23			RK74HB1J221J	CHIP-COM 220 J 1/16W	
CP24		*	RK74HB1J223J	CHIP-COM 22K J 1/16W	
CP25,26			RK74HB1J102J	CHIP-COM 1.0K J 1/16W	
CP27,28			R90-1021-05	MULTI-COMP 3.3K X2	
CP30		*	RK74HB1J223J	CHIP-COM 22K J 1/16W	
CP31			RK74HB1J473J	CHIP-COM 47K J 1/16W	
CP32			R90-0723-05	MULTI-COMP 47K X2	
CP200			RK74GA1J102J	CHIP-COM 1.0K J 1/16W	
CP300		*	RK74HB1J223J	CHIP-COM 22K J 1/16W	
R1			RK73GB2A471J	CHIP R 470 J 1/10W	
R2			RK73GB2A102J	CHIP R 1.0K J 1/10W	
R3			RK73GB2A4R7J	CHIP R 4.7 J 1/10W	

K1 : KDC-MP925 E1 : KDC-W8027

△ Indicates safety critical components.

PARTS LIST

* New parts

Parts without **Parts No.** are not supplied.

Les articles non mentionnés dans le **Parts No.** ne sont pas fournis.

Teile ohne **Parts No.** werden nicht geliefert.

DISPLAY UNIT (X16-2530-11)

Ref. No.	Add	New	Parts No.	Description	Destination
R4			RK73GB2A223J	CHIP R 22K J 1/10W	
R5			RK73GB2A101J	CHIP R 100 J 1/10W	
R6			RK73GB2A223J	CHIP R 22K J 1/10W	
R7			RK73GB2A102J	CHIP R 1.0K J 1/10W	
R8,9			RK73GB2A223J	CHIP R 22K J 1/10W	
R10			RK73GB2A101J	CHIP R 100 J 1/10W	
R11			RK73GB2A223J	CHIP R 22K J 1/10W	
R12			RK73GB2A102J	CHIP R 1.0K J 1/10W	
R14			RK73GB2A101J	CHIP R 100 J 1/10W	
R16			RK73GB2A102J	CHIP R 1.0K J 1/10W	
R17			RK73GB2A473J	CHIP R 47K J 1/10W	
R18			RK73GB2A393J	CHIP R 39K J 1/10W	
R19,20			RK73GB2A473J	CHIP R 47K J 1/10W	
R21			RK73GB2A103J	CHIP R 10K J 1/10W	
R22			RK73GB2A152J	CHIP R 1.5K J 1/10W	
R23			RK73GB2A222J	CHIP R 2.2K J 1/10W	
R24			RK73GB2A104J	CHIP R 100K J 1/10W	
R25			RK73GB2A220J	CHIP R 22 J 1/10W	
R26,27			RK73GB2A103J	CHIP R 10K J 1/10W	
R28-30			RK73GB2A222J	CHIP R 2.2K J 1/10W	
R31			RK73GB2A101J	CHIP R 100 J 1/10W	
R32			RK73GB2A104J	CHIP R 100K J 1/10W	
R33			RK73GB2A102J	CHIP R 1.0K J 1/10W	
R34			RK73GB2A100J	CHIP R 10 J 1/10W	
R35			RK73GB2A153J	CHIP R 15K J 1/10W	
R36			RK73GB2A103J	CHIP R 10K J 1/10W	
R37,38			RK73GB2A274J	CHIP R 270K J 1/10W	
R39			RK73GB2A223J	CHIP R 22K J 1/10W	
R40			RK73GB2A333J	CHIP R 33K J 1/10W	
R44			RK73GB2A104J	CHIP R 100K J 1/10W	
R45			RK73GB2A181J	CHIP R 180 J 1/10W	
R46			RK73GB2A472J	CHIP R 4.7K J 1/10W	
R47			RK73GB2A331J	CHIP R 330 J 1/10W	
R48			RK73GB2A104J	CHIP R 100K J 1/10W	
R49,50			RK73GB2A101J	CHIP R 100 J 1/10W	
R200		*	RK73EB2E3R3J	CHIP R 3.3 J 1/4W	
R201-203			RK73GB2A473J	CHIP R 47K J 1/10W	
R204			RK73GB2A472J	CHIP R 4.7K J 1/10W	
R206			RK73GB2A223J	CHIP R 22K J 1/10W	
R300			RK73GB2A393J	CHIP R 39K J 1/10W	
D1-5			DA204U	DIODE	
ED1		*	MN19236A	FLUORESCENT INDICATOR TUBE	
IC1		*	703132GJ011-A	MICROCONTROLLER IC	
IC2		*	MX23L3213TG114	ROM IC	
IC4		*	S-816A34AMCT2G	ANALOGUE IC	
IC5		*	S-816A25AMCT2G	ANALOGUE IC	
IC6			TC74HC4050AFT	MOS-IC	
IC7			TC7WT126FU	MOS-IC	
IC8			RS-171	ANALOGUE IC	
IC9		*	TC7WH32FU-F	MOS-IC	
IC10			BA3830F	ANALOGUE IC	
Q1			2SB1188(Q,R)	TRANSISTOR	
Q2			2SB1132	TRANSISTOR	
Q3			2SC2713	TRANSISTOR	
Q4			2SA1163	TRANSISTOR	

Ref. No.	Add	New	Parts No.	Description	Destination
Q5,6			2SA1774	TRANSISTOR	
Q7			DTC114EE	DIGITAL TRANSISTOR	
Q8			2SA1774	TRANSISTOR	
Q9			2SC4667	TRANSISTOR	
Q11			UMX2N	TRANSISTOR	
Q200			2SC4617	TRANSISTOR	
SWITCH UNIT (X16-2560-10)					
D1-10			B30-1605-05	LED (2COLOR PG/RED)	
D11-15			B30-1564-05	LED (1608,BLUE)	
D17-22			B30-1564-05	LED (1608,BLUE)	
D24			B30-1566-05	LED (1608,RED)	
C1-5			CK73GB1H103K	CHIP C 0.010UF K	
C7-12			CK73GB1H103K	CHIP C 0.010UF K	
CN1			E41-0419-05	FLAT CABLE CONNECTOR (24PIN)	
R1,2			RK73FB2B471J	CHIP R 470 J 1/8W	
R3,4			RK73FB2B301J	CHIP R 300 J 1/8W	
R5			RK73FB2B471J	CHIP R 470 J 1/8W	
R6-10			RK73FB2B181J	CHIP R 180 J 1/8W	
R11			RK73GB2A241J	CHIP R 240 J 1/10W	
R12			RK73GB2A332J	CHIP R 3.3K J 1/10W	
R13			RK73GB2A103J	CHIP R 10K J 1/10W	
R14			RK73GB2A332J	CHIP R 3.3K J 1/10W	
R15			RK73GB2A103J	CHIP R 10K J 1/10W	
R16			RK73GB2A222J	CHIP R 2.2K J 1/10W	
R17			RK73GB2A103J	CHIP R 10K J 1/10W	
S1			S70-0901-05	TACT SWITCH	
S2-9		*	S70-0912-05	TACT SWITCH	
S10			S70-0901-05	TACT SWITCH	
S11-20		*	S70-0912-05	TACT SWITCH	
S21			T99-0445-05	ROTARY ENCODER	
D25			DAN222	DIODE	
Q1			DTA114YUA	DIGITAL TRANSISTOR	
Q1			UN5114	DIGITAL TRANSISTOR	
Q2-4			2SD2114K	TRANSISTOR	
CD PLAYER UNIT (X32-5540-00)					
C1,2			CK73GB1H222K	CHIP C 2200PF K	
C3,4			CK73GB0J105K	CHIP C 1.0UF K	
C5			CK73GB1C104K	CHIP C 0.10UF K	
C6			CK73GB1H103K	CHIP C 0.010UF K	
C7-9			CK73GB0J105K	CHIP C 1.0UF K	
C10-15			CK73GB1C104K	CHIP C 0.10UF K	
C16			CK73FB0J475K	CHIP C 4.7UF K	
C17			CK73FB0J106M	CHIP C 10UF M	
C18			CK73GB1C104K	CHIP C 0.10UF K	
C19			CK73FB0J475K	CHIP C 4.7UF K	
C20			CK73GB1C104K	CHIP C 0.10UF K	
C21			CK73GB1H102K	CHIP C 1000PF K	
C22,23			CK73GB0J105K	CHIP C 1.0UF K	
C24-27			CK73GB1C104K	CHIP C 0.10UF K	
C28			CK73FB0J106M	CHIP C 10UF M	
C29			CK73GB1C104K	CHIP C 0.10UF K	

K1 : KDC-MP925 E1 : KDC-W8027

△ Indicates safety critical components.

PARTS LIST

* New parts

Parts without **Parts No.** are not supplied.

Les articles non mentionnés dans le **Parts No.** ne sont pas fournis.

Teile ohne **Parts No.** werden nicht geliefert.

CD PLAYER UNIT (X32-5540-00)

Ref. No.	A d d	N e w	Parts No.	Description	Desti- nation
C30			CK73GB1H152K	CHIP C 1500PF K	
C31			CC73GCH1H470J	CHIP C 47PF J	
C32,33			CK73GB1C104K	CHIP C 0.10UF K	
C34			CC73GCH1H560J	CHIP C 56PF J	
C35,36			CK73GB1C104K	CHIP C 0.10UF K	
C37			CK73GB1H102K	CHIP C 1000PF K	
C38			CK73GB1H682K	CHIP C 6800PF K	
C39			CK73GB1C104K	CHIP C 0.10UF K	
C41			CK73GB1A334K	CHIP C 0.33UF K	
C42-45			CK73GB1C104K	CHIP C 0.10UF K	
C46			CK73GB1H682K	CHIP C 6800PF K	
C47			CK73GB1C104K	CHIP C 0.10UF K	
C48			CC73GCH1H040C	CHIP C 4.0PF C	
C49			CK73GB1H332K	CHIP C 3300PF K	
C50			CK73GB1C104K	CHIP C 0.10UF K	
C51			CC73GCH1H330J	CHIP C 33PF J	
C52			CK73FB1A225K	CHIP C 2.2UF K	
C53			CK73GB0J105K	CHIP C 1.0UF K	
C54,55			CK73GB1H103K	CHIP C 0.010UF K	
C56,57			CK73GB1H331K	CHIP C 330PF K	
C58			CK73GB1H472K	CHIP C 4700PF K	
C59-63			CK73GB1H152K	CHIP C 1500PF K	
C64			CK73GB1C104K	CHIP C 0.10UF K	
C66			CC73GCH1H120J	CHIP C 12PF J	
C67			CC73GCH1H180J	CHIP C 18PF J	
C68			CK73GB1H103K	CHIP C 0.010UF K	
C69			CK73FB1A225K	CHIP C 2.2UF K	
C70			CK73FB1A105K	CHIP C 1.0UF K	
C71			CK73FB0J106M	CHIP C 10UF M	
C72			CK73GB1H102K	CHIP C 1000PF K	
CN1			E41-2083-05	FLAT CABLE CONNECTOR (24PIN)	
CN2			E41-2068-05	FLAT CABLE CONNECTOR (16PIN)	
CN2			E41-2085-05	FLAT CABLE CONNECTOR (16PIN)	
L1,2			L92-0386-05	CHIP FERRITE	
X1			L77-2808-05	CRYSTAL RESONATOR (16.897849MHZ)	
X2			L78-0896-05	RESONATOR (16.00MHZ)	
CP1			RK74GA1J104J	CHIP-COM 100K J 1/16W	
CP2,3			RK74GA1J101J	CHIP-COM 100 J 1/16W	
CP4			RK74GA1J103J	CHIP-COM 10K J 1/16W	
CP5			RK74GA1J102J	CHIP-COM 1.0K J 1/16W	
CP6			RK74GA1J104J	CHIP-COM 100K J 1/16W	
CP7			RK74GB1J102J	CHIP-COM 1.0K J 1/16W	
CP8			RK74GA1J102J	CHIP-COM 1.0K J 1/16W	
CP9			RK74GB1J101J	CHIP-COM 100 J 1/16W	
CP10			RK74GB1J103J	CHIP-COM 10K J 1/16W	
CP11			RK74GB1J472J	CHIP-COM 4.7K J 1/16W	
CP12			RK74GA1J104J	CHIP-COM 100K J 1/16W	
CP13,14			RK74GB1J104J	CHIP-COM 100K J 1/16W	
CP15			RK74GA1J104J	CHIP-COM 100K J 1/16W	
CP16			RK74GB1J222J	CHIP-COM 2.2K J 1/16W	
R1			RK73GB2A100J	CHIP R 10 J 1/10W	
R2			R92-3494-05	CHIP R 5.6 J 1/2W	
R3,4			RK73FB2B331J	CHIP R 330 J 1/8W	
R5			RK73GB2A101J	CHIP R 100 J 1/10W	

Ref. No.	A d d	N e w	Parts No.	Description	Desti- nation
R6			RN73GH1J223D	CHIP R 22K D 1/16W	
R7			RK73GB2A104J	CHIP R 100K J 1/10W	
R8			RN73GH1J393D	CHIP R 39K D 1/16W	
R9			RK73GB2A104J	CHIP R 100K J 1/10W	
R10			RK73GB2A101J	CHIP R 100 J 1/10W	
R11,12			RK73GB2A104J	CHIP R 100K J 1/10W	
R13			RK73GB2A102J	CHIP R 1.0K J 1/10W	
R14-17			RK73GB2A104J	CHIP R 100K J 1/10W	
R18			RK73GB2A101J	CHIP R 100 J 1/10W	
R21-23			RK73GB2A103J	CHIP R 10K J 1/10W	
R24,25			RK73GB2A4R7J	CHIP R 4.7 J 1/10W	
R27			RK73GB2A104J	CHIP R 100K J 1/10W	
R28			RK73GB2A103J	CHIP R 10K J 1/10W	
R29			RK73GB2A102J	CHIP R 1.0K J 1/10W	
R31-33			RK73GB2A104J	CHIP R 100K J 1/10W	
R34			RK73GB2A472J	CHIP R 4.7K J 1/10W	
R35			RK73GB2A104J	CHIP R 100K J 1/10W	
R36			RK73FB2B4R7J	CHIP R 4.7 J 1/8W	
R37			RK73GB2A103J	CHIP R 10K J 1/10W	
R38			RK73GB2A221J	CHIP R 220 J 1/10W	
R39			RK73GB2A152J	CHIP R 1.5K J 1/10W	
R40			RK73GB2A274J	CHIP R 270K J 1/10W	
R42			RK73GB2A101J	CHIP R 100 J 1/10W	
R43			RK73GB2A393J	CHIP R 39K J 1/10W	
R44,45			RK73GB2A302J	CHIP R 3.0K J 1/10W	
R46			RK73GB2A105J	CHIP R 1.0M J 1/10W	
R47			RK73GB2A104J	CHIP R 100K J 1/10W	
R48,49			RK73GB2A331J	CHIP R 330 J 1/10W	
R50			RK73GB2A101J	CHIP R 100 J 1/10W	
R51			RK73GB2A392J	CHIP R 3.9K J 1/10W	
R52			RK73GB2A163J	CHIP R 16K J 1/10W	
R53			RK73GB2A123J	CHIP R 12K J 1/10W	
R54			RK73GB2A333J	CHIP R 33K J 1/10W	
R55			RK73GB2A103J	CHIP R 10K J 1/10W	
R56			RK73GB2A123J	CHIP R 12K J 1/10W	
R57,58			RK73GB2A133J	CHIP R 13K J 1/10W	
R59			RK73GB2A472J	CHIP R 4.7K J 1/10W	
R60			RK73GB2A123J	CHIP R 12K J 1/10W	
R61			RK73GB2A183J	CHIP R 18K J 1/10W	
R62			RK73GB2A432J	CHIP R 4.3K J 1/10W	
R63			RK73GB2A133J	CHIP R 13K J 1/10W	
R64			RK73GB2A241J	CHIP R 240 J 1/10W	
R65			RK73GB2A104J	CHIP R 100K J 1/10W	
R66			RK73GB2A472J	CHIP R 4.7K J 1/10W	
R67			RK73GB2A222J	CHIP R 2.2K J 1/10W	
R68,69			RK73GB2A104J	CHIP R 100K J 1/10W	
R70			RK73GB2A102J	CHIP R 1.0K J 1/10W	
S1,2			S68-0863-05	PUSH SWITCH	
S3			S68-0862-05	PUSH SWITCH	
D2			DA204U	DIODE	
D3			DAN202U	DIODE	
IC1			91CW12AFG-4VF6	MICROCONTROLLER IC	
IC2			UPD63712GC	MOS-IC	
IC3			TC94A20F-010	MOS-IC	

PARTS LIST

* New parts

Parts without **Parts No.** are not supplied.

Les articles non mentionnés dans le **Parts No.** ne sont pas fournis.

Teile ohne **Parts No.** werden nicht geliefert.

CD PLAYER UNIT (X32-5540-00)

Ref. No.	Add	New	Parts No.	Description	Destination	Ref. No.	Add	New	Parts No.	Description	Destination
IC4			BA5824FP	ANALOGUE IC		C100		*	C90-5624-05	ELECTRO 3900UF 16WV	K1
IC5			NJM2880U133	ANALOGUE IC		C100			C90-5626-05	ELECTRO 3900UF 16WV	E1
IC5			NJM2880U33	ANALOGUE IC		C101			C94-0032-05	ELECTRO 47UF 6.3WV	
IC6			S-1112B33MCG	ANALOGUE IC		C102			CC73GCH1H220J	CHIP C 22PF J	
IC6			XC6219B332MR	ANALOGUE IC		C103			CC73GCH1H270J	CHIP C 27PF J	
IC7			S-1112B25MCG	ANALOGUE IC		C104			CK73GB0J105K	CHIP C 1.0UF K	
IC7			XC6219B252MR	ANALOGUE IC		C106			CK73GB0J105K	CHIP C 1.0UF K	
IC8			TC7SH08FU	MOS-IC		C107			CK73GB1H103K	CHIP C 0.010UF K	
IC9			TAR5S33-F	ANALOGUE IC		C109			CK73GB1H102K	CHIP C 1000PF K	
Q1			2SK3018	FET		C110,111			CK73GB1H103K	CHIP C 0.010UF K	
Q3			UMD9N	TRANSISTOR		C199			CK73GB1C104K	CHIP C 0.10UF K	
Q4			2SK3018	FET		C199			CK73GB1H104K	CHIP C 0.10UF K	
Q5			UMD9N	TRANSISTOR		C201,202			C94-0161-05	ELECTRO 0.47UF 50WV	
Q6			UMD12N	TRANSISTOR		C203,204			CK73FB1C474K	CHIP C 0.47UF K	
Q7			DTC124EUA	DIGITAL TRANSISTOR		C205,206			C94-0032-05	ELECTRO 47UF 6.3WV	
Q8			2SB0970	TRANSISTOR		C207,208			CK73FB1C474K	CHIP C 0.47UF K	
Q9,10			DTC114YUA	DIGITAL TRANSISTOR		C209			CK73GB1E223K	CHIP C 0.022UF K	
ELECTRIC UNIT (X34-3030-10, X34-3032-71)						C209			CK73GB1H223K	CHIP C 0.022UF K	
C2			CK73GB1H103K	CHIP C 0.010UF K		C210			CK73GB1H103K	CHIP C 0.010UF K	
C3		*	C90-5619-05	ELECTRO 220UF 16WV		C211			CK73GB1A474K	CHIP C 0.47UF K	
C4			CK73GB1H103K	CHIP C 0.010UF K		C212			CC73GCH1H151J	CHIP C 150PF J	
C5			C94-0039-05	ELECTRO 10UF 16WV		C213			CK73GB1C104K	CHIP C 0.10UF K	
C6			C94-0033-05	ELECTRO 100UF 6.3WV		C213			CK73GB1H104K	CHIP C 0.10UF K	
C7			CK73FB1C105K	CHIP C 1.0UF K		C214			CK73GB1H103K	CHIP C 0.010UF K	
C8		*	C94-0188-05	ELECTRO 220UF 10WV		C215			C94-0042-05	ELECTRO 47UF 16WV	
C9		*	C94-0186-05	ELECTRO 100UF 10WV		C216-223			CK73FB1C105K	CHIP C 1.0UF K	
C10			CE32AZ1E221M	CHIP EL 220UF 25WV		C224			CK73GB1C104K	CHIP C 0.10UF K	
C11			CK73GB1H332K	CHIP C 3300PF K		C224			CK73GB1H104K	CHIP C 0.10UF K	
C12			CE32AZ1C221M	CHIP EL 220UF 16WV		C225			CK73GB1H103K	CHIP C 0.010UF K	
C13			CK73GB0J105K	CHIP C 1.0UF K		C226-231			CK73GB1E473K	CHIP C 0.047UF K	
C14			CK73EB1C225K	CHIP C 2.2UF K		C226-231			CK73GB1H473K	CHIP C 0.047UF K	
C15			CK73GB1H103K	CHIP C 0.010UF K		C232			CK73FB1C105K	CHIP C 1.0UF K	
C16			CE32AZ1C101M	CHIP EL 100UF 16WV		C233			C92-0667-05	ELECTRO 10UF 10WV	
C17			CK73GB1H103K	CHIP C 0.010UF K		C234			CK73GB1E333K	CHIP C 0.033UF K	
C18			CE32AZ1C101M	CHIP EL 100UF 16WV		C234			CK73GB1H333K	CHIP C 0.033UF K	
C21			CK73FB1A225K	CHIP C 2.2UF K		C235			CK73GB1H103K	CHIP C 0.010UF K	
C22			C93-1218-05	CHIP C 0.010UF K		C236			CK73GB1A334K	CHIP C 0.33UF K	
C23			C90-5375-05	ELECTRO 33UF 63WV		C237			CK73GB1A474K	CHIP C 0.47UF K	
C30			C94-0044-05	ELECTRO 4.7UF 25WV	K1	C238			CC73GCH1H221J	CHIP C 220PF J	
C31			C90-2962-05	ELECTRO 100UF 16WV	K1	C239			CK73GB1H103K	CHIP C 0.010UF K	
C32-35			CK73EB1C225K	CHIP C 2.2UF K	K1	C240,241			C92-0667-05	ELECTRO 10UF 10WV	
C36			C94-0040-05	ELECTRO 22UF 16WV	K1	C250			CE32AT1H2R2M	CHIP EL 2.2UF 50WV	E1
C37			CK73GB1E223K	CHIP C 0.022UF K	K1	C250			C92-0687-05	ELECTRO 2.2UF 50WV	K1
C37			CK73GB1H223K	CHIP C 0.022UF K	K1	C251			CK73FB1C334K	CHIP C 0.33UF K	
C38			CK73GB1H103K	CHIP C 0.010UF K	K1	C252			CK73GB1A334K	CHIP C 0.33UF K	
C39,40			CK73EB1C225K	CHIP C 2.2UF K	K1	C253			CK73FB1C334K	CHIP C 0.33UF K	
C41			CK73GB1H103K	CHIP C 0.010UF K		C254			CK73GB1A334K	CHIP C 0.33UF K	
C42			CK73GB1E223K	CHIP C 0.022UF K		C255			CK73FB1C334K	CHIP C 0.33UF K	
C42			CK73GB1H223K	CHIP C 0.022UF K		C256			CK73GB1A334K	CHIP C 0.33UF K	
C43			CK73FB1C105K	CHIP C 1.0UF K		C257			CK73FB1C334K	CHIP C 0.33UF K	
C44,45			CK73GB1H103K	CHIP C 0.010UF K		C258			CK73GB1A334K	CHIP C 0.33UF K	
C46			CK73GB1H102K	CHIP C 1000PF K		C259			CE32AT1H010M	CHIP EL 1.0UF 50WV	E1
C47			CK73FB1C105K	CHIP C 1.0UF K		C259			C92-0686-05	ELECTRO 1UF 50WV	K1
C48			CK73GB1H103K	CHIP C 0.010UF K		C260-263			CK73GB1C104K	CHIP C 0.10UF K	
						C260-263			CK73GB1H104K	CHIP C 0.10UF K	

K1 : KDC-MP925 E1 : KDC-W8027

△ Indicates safety critical components.

PARTS LIST

* New parts

Parts without **Parts No.** are not supplied.

Les articles non mentionnés dans le **Parts No.** ne sont pas fournis.

Teile ohne **Parts No.** werden nicht geliefert.

ELECTRIC UNIT (X34-3030-10, X34-3032-71)

Ref. No.	A d d	N e w	Parts No.	Description	Desti- nation
C264,265			C94-0039-05	ELECTRO 10UF 16WV	E1
C264,265			C94-0040-05	ELECTRO 22UF 16WV	K1
C266,267			C94-0039-05	ELECTRO 10UF 16WV	K1
C268,269			C94-0039-05	ELECTRO 10UF 16WV	E1
C268,269			C94-0040-05	ELECTRO 22UF 16WV	K1
C270,271			C94-0039-05	ELECTRO 10UF 16WV	K1
C272-275			C94-0179-05	ELECTRO 0.22UF 50WV	
C276			CK73FB1C105K	CHIP C 1.0UF K	
C277			C94-0041-05	ELECTRO 33UF 16WV	
C278			C90-5663-05	ELECTRO 1UF 50WV	
C279			C94-0051-05	ELECTRO 1UF 50WV	
C280-285			CK73GB1H222K	CHIP C 2200PF K	K1
C286			CK73GB1H103K	CHIP C 0.010UF K	
C287-289			CK73FB1H104K	CHIP C 0.10UF K	
C290,291			CK73GB1H103K	CHIP C 0.010UF K	
C292-296			CK73EB1A475K	CHIP C 4.7UF K	
C297,298			C92-0671-05	ELECTRO 10UF 16WV	E1
C297,298			C92-0672-05	ELECTRO 22UF 16WV	K1
C299,300			C94-0039-05	ELECTRO 10UF 16WV	K1
C303-305			CK73GB1H103K	CHIP C 0.010UF K	
C307			CK73GB1H103K	CHIP C 0.010UF K	
C309,310			CC73GCH1H100D	CHIP C 10PF D	
C311			CC73GCH1H331J	CHIP C 330PF J	
C312			CK73FB1A225K	CHIP C 2.2UF K	
C313			CK73GB1H103K	CHIP C 0.010UF K	
C314			C94-0039-05	ELECTRO 10UF 16WV	
C316-319			CK73GB1A224K	CHIP C 0.22UF K	
C501			CK73FB1C105K	CHIP C 1.0UF K	E1
C502-504			CK73GB1H103K	CHIP C 0.010UF K	
C601,602			CK73GB1C104K	CHIP C 0.10UF K	
C601,602			CK73GB1H104K	CHIP C 0.10UF K	
C603			CK73GB1H103K	CHIP C 0.010UF K	
C701			CK73GB1A474K	CHIP C 0.47UF K	
CN1			E41-0224-05	PIN ASSY (12PIN)	
CN2			E40-3237-05	PIN ASSY (2PIN)	
CN3			E41-0384-05	PIN ASSY (16PIN)	
CN4			E40-9527-05	FLAT CABLE CONNECTOR (24PIN)	
CN4			E41-0213-05	FLAT CABLE CONNECTOR (24PIN)	
CN5			E40-9368-05	FLAT CABLE CONNECTOR (28PIN)	
CN6			E41-0399-05	FLAT CABLE CONNECTOR (15PIN)	
CN7			E41-0009-05	PIN ASSY (2PIN)	
J1			E58-0863-15	RECTANGULAR RECEPTACLE (16PIN)	
P1			E23-0745-05	TERMINAL	
W2			E30-6218-05	CORD WITH PLUG (ANT)	
L1			L33-1170-05	CHOKE COIL ASSY	
L2			L33-1126-05	CHOKE COIL	
L3			L33-1029-05	SMALL FIXED INDUCTOR	
L4			L40-2205-34	SMALL FIXED INDUCTOR (22UH)	K1
L7			L33-1039-05	LINE FILTER COIL	
L101			L40-4795-34	SMALL FIXED INDUCTOR	
L101			L40-4795-68	SMALL FIXED INDUCTOR (4.7UH)	
L102			L92-0075-05	CHIP FERRITE	
L201			L40-4795-34	SMALL FIXED INDUCTOR	
L201			L40-4795-68	SMALL FIXED INDUCTOR (4.7UH)	

Ref. No.	A d d	N e w	Parts No.	Description	Desti- nation
L303-307			L40-4795-34	SMALL FIXED INDUCTOR	
L303-307			L40-4795-68	SMALL FIXED INDUCTOR (4.7UH)	
X1			L78-0821-05	RESONATOR (20MHz)	
X2			L77-2738-05	CRYSTAL RESONATOR (32.768KHz)	
X3			L77-2002-05	CRYSTAL RESONATOR (4.332MHz)	
U	2D		N83-3005-46	PAN HEAD TAPTITE SCREW	
X	2D		N80-3008-46	PAN HEAD TAPTITE SCREW	
Y	2D		N83-3010-46	PAN HEAD TAPTITE SCREW	
Z	2D		N84-2004-46	PAN HEAD TAPTITE SCREW	
R1			RK73FB2B223J	CHIP R 22K J 1/8W	
R2			RK73GB2A101J	CHIP R 100 J 1/10W	
R3			RK73GB2A223J	CHIP R 22K J 1/10W	
R4			RK73GB2A222J	CHIP R 2.2K J 1/10W	
R5			RK73FB2B221J	CHIP R 220 J 1/8W	
R6			RK73GB2A153J	CHIP R 15K J 1/10W	
R7			R92-3032-05	CHIP R 4.3K D 1/10W	
R8			R92-3047-05	CHIP R 24K D 1/10W	
R9			RK73FB2B152J	CHIP R 1.5K J 1/8W	
R10			R92-3022-05	METAL R 750 D 1/10W	
R11			R92-3028-05	CHIP R 2.2K D 1/10W	
R12			RK73GB2A103J	CHIP R 10K J 1/10W	
R13			R92-2104-05	CHIP R 2.2 J 1W	
R14			RK73FB2B751J	CHIP R 750 J 1/8W	
R15			RK73GB2A473J	CHIP R 47K J 1/10W	
R16			RK73FB2B103J	CHIP R 10K J 1/8W	
R17			RK73GB2A102J	CHIP R 1.0K J 1/10W	K1
R18			RK73GB2A750J	CHIP R 75 J 1/10W	K1
R19			RK73GB2A272J	CHIP R 2.7K J 1/10W	K1
R20			RK73GB2A470J	CHIP R 47 J 1/10W	K1
R21			RK73GB2A752J	CHIP R 7.5K J 1/10W	K1
R22			RK73GB2A274J	CHIP R 270K J 1/10W	K1
R23			RK73GB2A563J	CHIP R 56K J 1/10W	K1
R24			RK73GB2A470J	CHIP R 47 J 1/10W	K1
R25			RK73GB2A103J	CHIP R 10K J 1/10W	K1
R26,27			RK73GB2A913J	CHIP R 91K J 1/10W	K1
R28			RK73FB2B472J	CHIP R 4.7K J 1/8W	
R29			RD14DB2H102J	SMALL-RD 1.0K J 1/2W	K1
R30			RK73GB2A223J	CHIP R 22K J 1/10W	K1
R31			RK73FB2B472J	CHIP R 4.7K J 1/8W	
R32			RK73FB2B561J	CHIP R 560 J 1/8W	E1
R33			RK73GB2A473J	CHIP R 47K J 1/10W	
R34			RK73GB2A223J	CHIP R 22K J 1/10W	
R35			RK73GB2A104J	CHIP R 100K J 1/10W	
R36			RK73FB2B103J	CHIP R 10K J 1/8W	
R37			RK73GB2A103J	CHIP R 10K J 1/10W	
R38			RK73GB2A822J	CHIP R 8.2K J 1/10W	
R41			RK73GB2A223J	CHIP R 22K J 1/10W	
R42			RD14DB2H332J	SMALL-RD 3.3K J 1/2W	
R43			RK73EB2E473J	CHIP R 47K J 1/4W	
R44			RK73GB2A183J	CHIP R 18K J 1/10W	
R45			RK73GB2A104J	CHIP R 100K J 1/10W	
R46,47			RK73EB2E103J	CHIP R 10K J 1/4W	
R48			RK73EB2E102J	CHIP R 1.0K J 1/4W	E1
R49			RD14DB2H102J	SMALL-RD 1.0K J 1/2W	K1

K1 : KDC-MP925 E1 : KDC-W8027

△ Indicates safety critical components.

PARTS LIST

* New parts

Parts without **Parts No.** are not supplied.

Les articles non mentionnés dans le **Parts No.** ne sont pas fournis.

Teile ohne **Parts No.** werden nicht geliefert.

ELECTRIC UNIT (X34-3030-10, X34-3032-71)

Ref. No.	Add	New	Parts No.	Description	Destination	Ref. No.	Add	New	Parts No.	Description	Destination
R101			RK73GB2A103J	CHIP R 10K J 1/10W		R208			RK73GB2A912J	CHIP R 9.1K J 1/10W	
R102			RK73GB2A153J	CHIP R 15K J 1/10W		R209			RK73GB2A363J	CHIP R 36K J 1/10W	
R103			RK73GB2A104J	CHIP R 100K J 1/10W		R210			RK73GB2A622J	CHIP R 6.2K J 1/10W	
R106			RK73GB2A103J	CHIP R 10K J 1/10W	K1	R217			RK73GB2A682J	CHIP R 6.8K J 1/10W	
R108,109			RK73GB2A103J	CHIP R 10K J 1/10W	E1	R218			RK73GB2A332J	CHIP R 3.3K J 1/10W	
R109			RK73GB2A103J	CHIP R 10K J 1/10W	K1	R219			RK73GB2A392J	CHIP R 3.9K J 1/10W	
R110			RK73GB2A104J	CHIP R 100K J 1/10W		R220,221			RK73FB2B361J	CHIP R 360 J 1/8W	
R111,112			RK73GB2A103J	CHIP R 10K J 1/10W		R222,223			RK73FB2B222J	CHIP R 2.2K J 1/8W	K1
R115,116			RK73GB2A102J	CHIP R 1.0K J 1/10W		R222,223			RK73FB2B223J	CHIP R 22K J 1/8W	E1
R117			RK73GB2A103J	CHIP R 10K J 1/10W		R224,225			RK73FB2B103J	CHIP R 10K J 1/8W	K1
R118-120			RK73GB2A102J	CHIP R 1.0K J 1/10W		R226,227			RK73FB2B223J	CHIP R 22K J 1/8W	K1
R121			RK73GB2A222J	CHIP R 2.2K J 1/10W		R228,229			RK73FB2B820J	CHIP R 82 J 1/8W	K1
R122-126			RK73GB2A101J	CHIP R 100 J 1/10W		R230,231			RK73EB2E181J	CHIP R 180 J 1/4W	E1
R127			RK73GB2A102J	CHIP R 1.0K J 1/10W		R232,233			RK73FB2B361J	CHIP R 360 J 1/8W	
R128			RK73GB2A104J	CHIP R 100K J 1/10W		R234,235			RK73FB2B222J	CHIP R 2.2K J 1/8W	K1
R129			RK73GB2A102J	CHIP R 1.0K J 1/10W		R234,235			RK73FB2B223J	CHIP R 22K J 1/8W	E1
R130			RK73GB2A104J	CHIP R 100K J 1/10W		R236,237			RK73FB2B103J	CHIP R 10K J 1/8W	K1
R131			RK73GB2A102J	CHIP R 1.0K J 1/10W		R238,239			RK73FB2B223J	CHIP R 22K J 1/8W	K1
R132			RK73GB2A104J	CHIP R 100K J 1/10W		R240,241			RK73FB2B820J	CHIP R 82 J 1/8W	K1
R133-136			RK73GB2A222J	CHIP R 2.2K J 1/10W		R242,243			RK73EB2E181J	CHIP R 180 J 1/4W	E1
R137			RK73GB2A102J	CHIP R 1.0K J 1/10W		R244,245			RK73FB2B361J	CHIP R 360 J 1/8W	
R138-140			RK73GB2A222J	CHIP R 2.2K J 1/10W		R246,247			RK73FB2B222J	CHIP R 2.2K J 1/8W	K1
R141			RK73GB2A102J	CHIP R 1.0K J 1/10W		R246,247			RK73FB2B223J	CHIP R 22K J 1/8W	E1
R142,143			RK73GB2A222J	CHIP R 2.2K J 1/10W		R248,249			RK73FB2B103J	CHIP R 10K J 1/8W	K1
R144			RK73GB2A102J	CHIP R 1.0K J 1/10W		R250,251			RK73FB2B223J	CHIP R 22K J 1/8W	K1
R145,146			RK73GB2A473J	CHIP R 47K J 1/10W		R252,253			RK73FB2B820J	CHIP R 82 J 1/8W	K1
R150,151			RK73GB2A104J	CHIP R 100K J 1/10W		R254,255			RK73EB2E181J	CHIP R 180 J 1/4W	E1
R152,153			RK73GB2A222J	CHIP R 2.2K J 1/10W		R256			RK73GB2A221J	CHIP R 220 J 1/10W	
R156			RK73GB2A104J	CHIP R 100K J 1/10W		R257			RK73GB2A223J	CHIP R 22K J 1/10W	
R158			RK73GB2A104J	CHIP R 100K J 1/10W		R259			RK73GB2A432J	CHIP R 4.3K J 1/10W	
R159,160			RK73GB2A471J	CHIP R 470 J 1/10W		R260			RK73GB2A100J	CHIP R 10 J 1/10W	
R161			RK73GB2A104J	CHIP R 100K J 1/10W		R261			RK73GB2A752J	CHIP R 7.5K J 1/10W	
R162			RK73GB2A103J	CHIP R 10K J 1/10W		R262			RK73EB2E4R7J	CHIP R 4.7 J 1/4W	
R163,164			RK73GB2A471J	CHIP R 470 J 1/10W		R263,264			RK73EB2E100J	CHIP R 10 J 1/4W	
R165,166			RK73GB2A472J	CHIP R 4.7K J 1/10W		R265,266			RK73GB2A102J	CHIP R 1.0K J 1/10W	
R167			RK73GB2A102J	CHIP R 1.0K J 1/10W		R267			RK73EB2E100J	CHIP R 10 J 1/4W	
R169			RK73GB2A102J	CHIP R 1.0K J 1/10W		R268			RK73EB2E4R7J	CHIP R 4.7 J 1/4W	
R170			RK73GB2A222J	CHIP R 2.2K J 1/10W		R269			RK73EB2E100J	CHIP R 10 J 1/4W	
R171,172			RK73GB2A471J	CHIP R 470 J 1/10W		R270			RK73GB2A473J	CHIP R 47K J 1/10W	
R173,174			RK73GB2A472J	CHIP R 4.7K J 1/10W		R271			RK73GB2A821J	CHIP R 820 J 1/10W	
R175			RK73GB2A333J	CHIP R 33K J 1/10W		R272,273			RK73GB2A103J	CHIP R 10K J 1/10W	
R176			RK73GB2A473J	CHIP R 47K J 1/10W		R274			RK73GB2A104J	CHIP R 100K J 1/10W	
R177			RK73GB2A222J	CHIP R 2.2K J 1/10W		R275			RK73GB2A473J	CHIP R 47K J 1/10W	
R178,179			RK73GB2A103J	CHIP R 10K J 1/10W		R276			RK73GB2A102J	CHIP R 1.0K J 1/10W	
R180			RK73GB2A222J	CHIP R 2.2K J 1/10W		R277			RK73GB2A473J	CHIP R 47K J 1/10W	
R181			RK73GB2A473J	CHIP R 47K J 1/10W		R278			RK73GB2A333J	CHIP R 33K J 1/10W	
R182			RK73GB2A104J	CHIP R 100K J 1/10W		R279,280			RK73GB2A334J	CHIP R 330K J 1/10W	
R183			RK73GB2A222J	CHIP R 2.2K J 1/10W	K1	R303			RK73FB2B102J	CHIP R 1.0K J 1/8W	
R183,184			RK73GB2A222J	CHIP R 2.2K J 1/10W	E1	R304			RK73GB2A223J	CHIP R 22K J 1/10W	
R186			RK73GB2A102J	CHIP R 1.0K J 1/10W		R305			RK73GB2A472J	CHIP R 4.7K J 1/10W	
R201			RK73GB2A103J	CHIP R 10K J 1/10W		R306-308			RK73GB2A222J	CHIP R 2.2K J 1/10W	
R202-204			RK73GB2A472J	CHIP R 4.7K J 1/10W		R501,502			RK73EB2E101J	CHIP R 100 J 1/4W	
R205			RK73GB2A134J	CHIP R 130K J 1/10W		R503-507			RK73EB2E472J	CHIP R 4.7K J 1/4W	
R206			RK73GB2A823J	CHIP R 82K J 1/10W		R508			RK73EB2E101J	CHIP R 100 J 1/4W	
R207			RK73GB2A473J	CHIP R 47K J 1/10W		R509-511			RK73EB2E471J	CHIP R 470 J 1/4W	

K1 : KDC-MP925 E1 : KDC-W8027

△ Indicates safety critical components.

PARTS LIST

* New parts

Parts without **Parts No.** are not supplied.

Les articles non mentionnés dans le **Parts No.** ne sont pas fournis.

Teile ohne **Parts No.** werden nicht geliefert.

ELECTRIC UNIT (X34-3030-10, X34-3032-71)

Ref. No.	A d d	N e w	Parts No.	Description	Desti- nation
R512			RK73EB2E102J	CHIP R 1.0K J 1/4W	
R513			RK73GB2A223J	CHIP R 22K J 1/10W	
R514			RK73GB2A392J	CHIP R 3.9K J 1/10W	
R515,516			RK73GB2A472J	CHIP R 4.7K J 1/10W	
R517,518			RK73EB2E101J	CHIP R 100 J 1/4W	
R519			RK73EB2E471J	CHIP R 470 J 1/4W	
R520			RK73EB2E472J	CHIP R 4.7K J 1/4W	
R522-524			RK73GB2A222J	CHIP R 2.2K J 1/10W	
R525			RK73GB2A102J	CHIP R 1.0K J 1/10W	
R526,527			RK73GB2A473J	CHIP R 47K J 1/10W	
R601,602			RK73GB2A104J	CHIP R 100K J 1/10W	
R603			RK73GB2A222J	CHIP R 2.2K J 1/10W	
R604,605			RK73GB2A103J	CHIP R 10K J 1/10W	
R606			RK73GB2A222J	CHIP R 2.2K J 1/10W	
R607			RK73GB2A911J	CHIP R 910 J 1/10W	
R608,609			RK73GB2A104J	CHIP R 100K J 1/10W	
R610			RK73GB2A222J	CHIP R 2.2K J 1/10W	
R611,612			RK73GB2A103J	CHIP R 10K J 1/10W	
R613			RK73GB2A222J	CHIP R 2.2K J 1/10W	
R614			RK73GB2A911J	CHIP R 910 J 1/10W	
R615-618			RK73GB2A102J	CHIP R 1.0K J 1/10W	
R620			RK73EB2E102J	CHIP R 1.0K J 1/4W	
R621			RK73GB2A472J	CHIP R 4.7K J 1/10W	
R623,624			RK73GB2A332J	CHIP R 3.3K J 1/10W	
R625,626			RK73GB2A102J	CHIP R 1.0K J 1/10W	
R701			RK73GB2A104J	CHIP R 100K J 1/10W	
W3			R92-1252-05	CHIP R 0 OHM J 1/16W	E1
D1			1N5393G-M5	DIODE	
D2			RB160L-40	DIODE	
D3			MA8056-M	ZENER DIODE	
D4			MA8082-L	ZENER DIODE	
D5			SFPB-54V	DIODE	
D6			MA8100-L	ZENER DIODE	
D7			MA4062(N)-L	ZENER DIODE	
D8			MA8110-M	ZENER DIODE	K1
D9			MA8056-M	ZENER DIODE	K1
D16			MA3056-M	ZENER DIODE	E1
D17			MA3047-M	ZENER DIODE	
D18			MA8068-M	ZENER DIODE	
D19			MA8062-M	ZENER DIODE	
D20,21			DAP202U	DIODE	
D20,21		*	LM1MA142WA-G	DIODE	
D20,21			MA142WA	DIODE	
D101			DAP202U	DIODE	
D101		*	LM1MA142WA-G	DIODE	
D101			MA142WA	DIODE	
D201,202			RD6.8M(B2)	ZENER DIODE	
D203			RD6.8MW	ZENER DIODE	
D204,205			RD6.8M(B2)	ZENER DIODE	
D206			RD6.8MW	ZENER DIODE	
D207,208			DAP202U	DIODE	
D207,208		*	LM1MA142WA-G	DIODE	
D207,208			MA142WA	DIODE	
D209-216			S1J	DIODE	

Ref. No.	A d d	N e w	Parts No.	Description	Desti- nation
D209-216			1SR154-400	DIODE	
D217			DA204K	DIODE	
D301			IMSA-6801	SURGE ABSORBER	
D501-505			MA3062WA	ZENER DIODE	E1
D503-505			MA3062WA	ZENER DIODE	K1
D506-509			DA204K	DIODE	
D601			DA204K	DIODE	
IC1		*	UPD703030GC041	MICROCONTROLLER IC	
IC2			TDA7411	ANALOGUE IC	
IC3			M5237ML	ANALOGUE IC	
IC4			TDA7560	ANALOGUE IC	
IC5			TDA7401	ANALOGUE IC	
IC6			NJM2195FJ1	ANALOGUE IC	
IC7			ICL7660SIBA	ANALOGUE IC	K1
IC8			S-80837CNNB	MOS-IC	
IC9			TC74HC02AF	MOS-IC	
IC10			NJM4565M-TE2	ANALOGUE IC	E1
IC10-13			NJM4565M-TE2	ANALOGUE IC	K1
IC14			TDA7479D	ANALOGUE IC	
IC15,16			LB1930M	ANALOGUE IC	
IC18			L9820D013TR	ANALOGUE IC	
IC19			LM2672M-ADJ	ANALOGUE IC	
IC20			TC7W66FK	MOS-IC	
Q1			2SA2057	TRANSISTOR	
Q2			2SC4081	TRANSISTOR	
Q3			2SA1576A	TRANSISTOR	
Q4			DTA124EUA	DIGITAL TRANSISTOR	
Q4			UN5112	DIGITAL TRANSISTOR	
Q5			DTC124EUA	DIGITAL TRANSISTOR	
Q5			UN5212	DIGITAL TRANSISTOR	
Q6			DTC144EUA	DIGITAL TRANSISTOR	
Q6			UN5213	DIGITAL TRANSISTOR	
Q7			DTA124EUA	DIGITAL TRANSISTOR	
Q7			UN5112	DIGITAL TRANSISTOR	
Q8,9			2SA2057	TRANSISTOR	
Q11			DTC124EUA	DIGITAL TRANSISTOR	
Q11			UN5212	DIGITAL TRANSISTOR	
Q12			DTA124EUA	DIGITAL TRANSISTOR	
Q12			UN5112	DIGITAL TRANSISTOR	
Q13			2SA2057	TRANSISTOR	
Q14			2SC4081	TRANSISTOR	
Q15			2SB1443	TRANSISTOR	K1
Q16,17			2SC4081	TRANSISTOR	K1
Q18,19			2SA1576A	TRANSISTOR	K1
Q20			2SC4081	TRANSISTOR	K1
Q21			2SA1576A	TRANSISTOR	K1
Q22			2SC4081	TRANSISTOR	K1
Q23			DTC114YUA	DIGITAL TRANSISTOR	K1
Q23			UN5214	DIGITAL TRANSISTOR	K1
Q24			2SB1240	TRANSISTOR	K1
Q25			DTA123JK	DIGITAL TRANSISTOR	E1
Q25			KRA105S	DIGITAL TRANSISTOR	E1
Q26			DTC144EUA	DIGITAL TRANSISTOR	
Q26			UN5213	DIGITAL TRANSISTOR	
Q27			2SC4081	TRANSISTOR	

K1 : KDC-MP925 E1 : KDC-W8027

△ Indicates safety critical components.

PARTS LIST

* New parts

Parts without **Parts No.** are not supplied.

Les articles non mentionnés dans le **Parts No.** ne sont pas fournis.

Teile ohne **Parts No.** werden nicht geliefert.

ELECTRIC UNIT (X34-3030-10, X34-3032-71)

Ref. No.	A d d	N e w	Parts No.	Description	Desti- nation
Q29			2SC4081	TRANSISTOR	
Q30,31			DTA124EUA	DIGITAL TRANSISTOR	
Q30,31			UN5112	DIGITAL TRANSISTOR	
Q201			DTC143TUA	DIGITAL TRANSISTOR	
Q201			UN5216	DIGITAL TRANSISTOR	
Q202			DTC124EUA	DIGITAL TRANSISTOR	
Q202			UN5212	DIGITAL TRANSISTOR	
Q203-208			DTC143TUA	DIGITAL TRANSISTOR	
Q203-208			UN5216	DIGITAL TRANSISTOR	
Q210			2SC4081	TRANSISTOR	
Q303			DTC124EUA	DIGITAL TRANSISTOR	
Q303			UN5212	DIGITAL TRANSISTOR	
Q304			2SB1188(Q,R)	TRANSISTOR	
Q305			DTC143TUA	DIGITAL TRANSISTOR	
Q305			UN5216	DIGITAL TRANSISTOR	
Q501			DTA124EUA	DIGITAL TRANSISTOR	
Q501			UN5112	DIGITAL TRANSISTOR	
Q502			2SB1427	TRANSISTOR	
Q503			DTC124EUA	DIGITAL TRANSISTOR	
Q503			UN5212	DIGITAL TRANSISTOR	
Q601			DTC124EUA	DIGITAL TRANSISTOR	
Q601			UN5212	DIGITAL TRANSISTOR	
Q602			2SC4081	TRANSISTOR	
Q603			DTC124EUA	DIGITAL TRANSISTOR	
Q603			UN5212	DIGITAL TRANSISTOR	
TH1			PTH9C42BD471Q	POSITIVE RESISTOR	
A2			W02-3430-05	ELECTRIC CIRCUIT MODULE	
A1			X86-3730-11	FRONT-END UNIT	K1
A1			X86-3732-70	FRONT-END UNIT	E1
CD MECHANISM ASSY (X92-4900-00)					
2	1B	*	A10-4884-02	CHASSIS	
5	1B	*	D10-4610-03	ARM ASSY	
8	2A	*	D10-4608-03	LEVER ASSY	
10	3A	*	D10-4602-03	ARM	
11	2A	*	D10-4603-03	ARM	
12	3A	*	D10-4604-03	ARM	
13	3A	*	D10-4605-03	ARM	
14	3B	*	D10-4613-03	ARM	
15	2A	*	D10-4615-03	SLIDER	
16	3B	*	D10-4617-02	SLIDER	
17	3B	*	D10-4618-03	SLIDER	
18	3B	*	D10-4614-04	ARM	
19	3B	*	D10-4606-04	ARM	
22	2A	*	D13-2174-04	GEAR	
23	2B	*	D13-2180-04	GEAR	
24	3B	*	D13-2181-04	GEAR	
25	3B	*	D13-2182-04	GEAR	
26	3B	*	D13-2175-04	WORM	
27	3B	*	D13-2176-04	GEAR	
28	3B	*	D13-2177-04	GEAR	
29	3B	*	D13-2178-04	GEAR	
30	3B	*	D13-2183-04	GEAR	

Ref. No.	A d d	N e w	Parts No.	Description	Desti- nation
31	3B	*	D13-2184-04	GEAR	
32	2B	*	D13-2173-03	RACK (GEAR)	
33	2A	*	D14-0763-04	ROLLER	
35	2B	*	D21-2389-04	SHAFT	
36	1A	*	D23-0955-04	RETAINER	
37	1B	*	D39-0246-05	DAMPER	
38	2B	*	G01-3095-04	EXTENSION SPRING	
39	2A	*	G01-3093-04	TORSION COIL SPRING	
40	2A	*	G01-3094-04	EXTENSION SPRING	
41	1B	*	G01-3091-04	EXTENSION SPRING	
42	2A	*	G01-3092-04	EXTENSION SPRING	
43	1B	*	G01-3090-04	EXTENSION SPRING	
44	2B	*	G02-1413-04	FLAT SPRING	
45	2B	*	G02-1414-04	FLAT SPRING	
51	1A	*	J21-9753-02	MOUNTING HARDWARE	
52	3B	*	J21-9755-02	MOUNTING HARDWARE	
53	1B	*	J21-9752-03	MOUNTING HARDWARE	
55	1A	*	J90-1014-01	GUIDE	
56	1B	*	J90-1024-03	GUIDE	
DFPC1	3A		J84-0141-05	FLEXIBLE PRINTED WIRING BOARD	
A	2B	*	N09-6192-05	TAPPING SCREW (P2X8COUNTERSU)	
B	1B	*	N09-6191-05	STEPPED SCREW (M1.7TOTAL8BON)	
C	2B		N09-6004-05	MACHINE SCREW (M1.7X2.5 IB-L)	
E	2B	*	N09-6193-05	MACHINE SCREW (M2X2PAN-HEAD#)	
F	1A	*	N09-6194-05	TAPPING SCREW (P2X5BINDING-H)	
G	2A		N19-2163-04	FLAT WASHER	
H	1B		N39-2020-46	PAN HEAD MACHIN SCREW	
J	1B	*	N09-6196-05	TAPTITE SCREW (S2X3.5PRECISI)	
DM1	3B		T42-1066-04	DC MOTOR ASSY (SPINDOL)	
DM2	3B		T42-1067-04	DC MOTOR ASSY (LOADING)	
DPU1	2B		X93-2010-00	OPTICAL PICKUP ASSY	

K1 : KDC-MP925 E1 : KDC-W8027

△ Indicates safety critical components.

KDC-MP925/W8027

SPECIFICATIONS

KDC-MP925

FM
Frequency Range (Frequency step) 87.9MHz~107.9MHz (200kHz)
Channel Space Selection 50k/200kHz
Usable Sensitivity (S/N 30dB) 9.3dBf (0.8µV/75Ω)
Quieting Sensitivity (S/N 50dB) 15.2dBf (1.6µV/75Ω)
Frequency Response (±3.0dB) 30Hz~15kHz
S/N 70dB (MONO)
Selectivity (DIN) ≥80dB (±400kHz)
Stereo Separation 40dB (1kHz)

AM

Frequency Range (Frequency step) 530kHz~1700kHz (10kHz)
Channel Space Selection 9k/10kHz
Usable Sensitivity (S/N 20dB) 28dBµ (25µV)

CD

Laser Diode GaAlAs
Digital Filter (D/A) 8 Times OverSampling
D/A Converter 1 Bit
Spindle Speed (CD-DA/MP3/WMA) 1000~400rpm (CLV 2 times)
Wow & Flutter Below Mesurable Limit
Frequency Response 10Hz~20kHz (±1dB)
Total Harmonic Distortion 0.01% (1kHz)
S/N Ratio 105dB (1kHz)
Dynamic Range 93dB
Channel Separation 95dB
MP3 Decode Compliant with MPEG-1/2 Audio Layer-3
WMA Decode Compliant with Windows Media Audio

Preout Level/Load-Unbalanced 5000mV/10kΩ (CD/CD-CH)
Preout Impedance 80Ω

AUX Input

Frequency Response 20Hz~20kHz (±1dB)
Input Maximum Voltage 1200mV
Input Impedance 100kΩ

AMP

Maximum Power 50W x 4
Full Bandwidth Power (at less than 1% THD) 22W x 4

TONE

Bass 100Hz±8dB
Middle 1kHz±8dB
Treble 12.5kHz±8dB

GENERAL

Operating voltage (11~16V allowable) 14.4V
Current Consumption 10A
Installation Size (W x H x D) 182 x 53 x 162 mm
..... 7-3/16 x 2-1/16 x 6-3/8 in
Weight 1.9kg (4.19lbs)

KDC-W8027

FM
Frequency Range (Frequency step) 87.5MHz~108.0MHz (50kHz)
Usable Sensitivity (S/N 26dB) 0.7µV/75Ω
Quieting Sensitivity (S/N 46dB) 1.6µV/75Ω
Frequency Response (±3.0dB) 30Hz~15kHz
S/N 65dB (MONO)
Selectivity (DIN) ≥80dB (±400kHz)
Stereo Separation 35dB (1kHz)

MW

Frequency Range (Frequency step) 531kHz~1611kHz (9kHz)
Usable Sensitivity (S/N 20dB) 25µV

LW

Frequency Range 153kHz~281kHz
Usable Sensitivity (S/N 20dB) 45µV

CD

Laser Diode GaAlAs
Digital Filter (D/A) 8 Times OverSampling
D/A Converter 1 Bit
Spindle Speed (CD-DA/MP3/WMA) 1000~400rpm (CLV 2 times)
Wow & Flutter Below Mesurable Limit
Frequency Response 10Hz~20kHz (±1dB)
Total Harmonic Distortion 0.01% (1kHz)
S/N Ratio 105dB (1kHz)
Dynamic Range 93dB
Channel Separation 95dB
MP3 Decode Compliant with MPEG-1/2 Audio Layer-3
WMA Decode Compliant with Windows Media Audio

Preout Level/Load-Unbalanced 2000mV/10kΩ (CD/CD-CH)
Preout Impedance ≤600Ω

AUX Input

Frequency Response 20Hz~20kHz (±1dB)
Input Maximum Voltage 1200mV
Input Impedance 100kΩ

AMP

Maximum Power 50W x 4
PWR DIN45324, +B=14.4V 30W x 4

TONE

Bass 60Hz~150Hz±8dB
Middle 500Hz~2kHz±8dB
Treble 10kHz~17.5kHz±8dB

GENERAL

Operating voltage (11~16V allowable) 14.4V
Current Consumption 10A
Installation Size (W x H x D) 182 x 53 x 162 mm
Weight 1.9kg

KENWOOD follows a policy of continuous advancements in development. For this reason specifications may be changed without notice.

KENWOOD CORPORATION

2967-3, Ishikawa-machi, Hachioji-shi, Tokyo, 192-8525 Japan

KENWOOD USA CORPORATION
P.O. Box 22745, 2201 East Dominguez Street, Long Beach, CA 90801-5745, U.S.A.

KENWOOD ELECTRONICS CANADA INC.
6070 Kestrel Road, Mississauga, Ontario, Canada L5T 1S8

KENWOOD ELECTRONICS LATIN AMERICA S.A.
P.O. Box 55-2791 Pañilla, Plaza Credicorp Bank Panama,
Piso 9, Oficina 901, Calle 50, Panama, Rep. de Panama

KENWOOD ELECTRONICS BRASIL LTDA.
Alameda Ministro Rocha Azevedo No. 456,
Edifício Jaú, 10o Andar, Cerqueira César, Cep 0140-001,
São Paulo-SP-Brasil

KENWOOD ELECTRONICS UK LIMITED
Kenwood House, Dwight Road, Watford, Herts, WD18 9EB, United Kingdom

KENWOOD ELECTRONICS DEUTSCHLAND GMBH
Rembrücker-Str. 15, 63150 Heusenstamm, Germany

KENWOOD ELECTRONICS FRANCE S.A.
13, Boulevard Ney, 75018 Paris, France

KENWOOD ELECTRONICS BELGIUM N.V.
Leuvensesteenweg 248 J, 1800 Vilvoorde, Belgium

KENWOOD ELECTRONICS ITALIA S.p.A.
Via G. Sirtori 7/9, 20129 Milano, Italy

KENWOOD IBÉRICA S.A.
Bolivia, 239-08020 Barcelona, Spain

KENWOOD ELECTRONICS AUSTRALIA PTY. LTD. (A.C.N. 001 499 074)
16 Giffnock Avenue, Centrecourt Estate, North Ryde,
N.S.W. 2113, Australia

KENWOOD ELECTRONICS (HONG KONG) LTD.
Unit 3712-3724, Level 37, Tower 1, Metroplaza, 223 Hing Fong Road, Kwai Fong, N.T.,
Hong Kong

KENWOOD ELECTRONICS GULF FZE
P.O. Box 61318, Jebel Ali, Dubai, U.A.E.

KENWOOD ELECTRONICS (THAILAND) CO., LTD.
956 Udom Vidhya Building (Olympia) Rama IV Road, Silom, Bangrak, Bangkok 10500 Thailand

KENWOOD ELECTRONICS SINGAPORE PTE. LTD.
1 Genting Lane, #07-00, Kenwood Building, Singapore, 349544

KENWOOD ELECTRONICS (MALAYSIA) SDN BHD
#4.01 Level 4, Wisma Academy Lot 4A, Jalan 19/1, 46300 Petaling Jaya, Selangor Darul Ehsan,
Malaysia